 एच०ई०सी० ISO 9001:2000	HEAVY MACHINE BUILDING PLANT HEAVY ENGINEERING CORPORATION LIMITED (A Govt. of India Enterprise) Ranchi – 834 004 (INDIA)
---	--

premshankarpaswan@hecltd.com

Web : www.hecltd.com

Tender Enquiry No. HMB/PUR/20/37/MISC-6208

Date: 22/01/2021

LIMITED OPEN TENDER

Sub: E-tendering with e-price bids for supply of Rubber materials, Oil seals, Springs, Chains etc.

Tenders are invited on line through website. Tenders are to be submitted strictly as per guidelines furnished in the website of <http://etenders.gov.in> hereunder:

INSTRUCTION TO BIDDERS (ITB)

1.0 Tender Summary :

Tender Ref No.	Enquiry No. HMB/PUR/20/37/MISC-6208 Date: 22/01/2021	
Item details	Rubber materials, Oil seals, Springs, Chains etc.	
Cost of Tender documents / Tender Fee	Not Applicable	
Mode of Tender:	E tender with e price bid	
Earnest Money Deposit (EMD) (To be submitted in the form of DD / BG in favor of Heavy Engineering Corporation Limited, Payable at Ranchi)	NIL	
Type of tender	Two Bid tender	
Last date and time for on-line submission of tender	28/01/2021	UPTO 13 Hrs (IST)
Due date and time for on-line opening of tender Part 1 only:	29/01/2021	AT 15 Hrs (IST)
Due date and time for online opening of Price bid of technically suitable firms	Will be intimated through e-tender portal	
(Under unforeseen circumstances and if the due date falls on holiday, the tender will be opened on the next full working day at same time)		

Bidders are requested to submit their most competitive offer through e- procurement mode only. Offer submitted through offline mode will not be considered. For more information please visit our website <https://etenders.gov.in/e procure/app>.

Prospective Tenderers are advised to get register themselves only on at NIC e-tender portal i.e. <https://etenders.gov.in/eprocure/app>, obtain 'User ID' & 'Password' and go through the 'Self Help files' available in the Home Page after log in to the portal <http://etenders.gov.in>. They should also obtain Class III Digital Signature Certificate (DSC) in parallel which is essentially required for submission of their application. Detailed instructions for online bid submission is mentioned below. No registration fee would be charged from the bidders.

Bidders are required to upload the bid along with all supporting documents including priced part (BoQ) only on the e-tendering website (<https://etenders.gov.in/eprocure/app>), on or before the due date and time for submission of bid.

NOTE: HEC reserves the right to extend / change the schedule of any activity by intimating the bidders through a notification on the e-tender portal.

2.0 Contents of tender documents:

1	Techno-Commercial Terms and Conditions of NIT	Annexure "A" & Annexure 'B'
2	Template for Price Bid/BOQ format for online submission by the bidder	BOQ.xls

3.0 Requirements for Vendors:

- A) P.C. connected with internet.
- B) Registration with Service provider portal <https://etenders.gov.in>
- C) The vendor should possess a Class-II or Class III Digital Signature certificate (Mandatory). (Bids will not be recorded without Digital Signature Certificate.)
- D) In case of any clarification please contact M/s NIC, before the schedule time of the submission of bid. Contact Person:- **Shri Kushal Kumar: 09852923855 / 7903884318**
- E) Registration / Enrollment of Bidder on e- tender Portal of HEC: In order to submit the bid, the bidders have to get themselves registered online on the e- tender portal of HEC Ltd with valid Digital Signature Certificate (DSC) issued from any agency authorized by CCA and which can be traced upto the chain of trust to the Root Certificate of CCA. The online Registration of the Bidders on the portal will be free of cost and one time activity only. The registration should be in the name of the bidder, whereas DSC holder may be either bidder himself or his duly authorized person.

4.0 For **registration**, Submission procedure and method of correspondence etc. Please visit our website: <https://www.hecltd.com> / <https://etenders.gov.in> and click on the relevant link for help.

5.0 Help for participating in e-tender:

The detailed method for participating in the e-procurement are available in the website <https://www.hecltd.com> or <https://etenders.gov.in> The bidders have to Log on to official website and then click on the specified links to start participating in the e-procurement process.

Bidders are also free to communicate with the contact person of the service provider to get all clarifications regarding the mode of the e-procurement process.

NB : (I)

- (I) Please note that there is no provision to take out the list of parties downloading the tender document from the above referred web site .
- (II) As such, tenderers are requested to see the website once again before due date of tender opening to ensure that they have not missed any corrigendum uploaded against the said tender after downloading the tender document. The responsibility of downloading the related corrigenda , if any , will be that of the downloading parties.
- (III) No separate intimation in respect of corrigendum to this NIT(if any) will be sent to tenderers who have down loaded the documents from website. Please see websites i.e.,<http://www.hecltd.com> or <http://www.etenders.gov.in>

6.0 The offer should be submitted (uploaded) strictly as per the terms and conditions and Procedures laid down in the website <https://etenders.nic.in> tender document failing which the offer is liable for rejection.

Bidders should download the complete NIT including the Annexure and read carefully before filling the details and uploading the documents.

7.0 The offers with any deviations to the NIT Terms and conditions shall be liable for rejection.

8.0 The bidder must upload all the documents required as per the terms of NIT. (Any other document uploaded which is not required as per the terms of the NIT shall not be considered.)

9.0 It may pleased be noted that E-tendering or e-procurement fall under the purview of the Information Technology Act 2000 and Information Technology (Amendment) Act 2008 and other relevant acts and subsequent amendments if any).

10.0 There will be no physical sale of the tender documents.

11.0 PREPARATION OF TENDER DOCUMENTS :

Tender is to be submitted in two bid system in the following manner and shall be submitted through electronic mode only:

a. Techno-commercial bid (Part 1) – The offer is to be scanned and uploaded in our portal consisting technical details

The commercial terms and conditions (as per annexure B). The format (Commercial sheet.xls) in excel format shall be downloaded and the same excel file duly filled by the bidder is to be uploaded while submitting the offer.. No price part is to be uploaded in this part

b. Part -II – Price-Bid/BOQ: This part of the offer should contain price portion .The format of Price Bid/BOQ which in excel format shall be downloaded by the bidder and rate offered by the bidder shall be filled in the excel file and uploaded the same excel file of e tendering system while submitting the offer.

The price bid/BOQ which is incomplete and not submitted as per the instructions given will be liable for rejection.

Note:

Bidders are requested to upload all the attachments /documents in one single PDF File in Other Important Documents (OID) or as indicated in the online instructions. For Example if more than one document is to be uploaded in support of Eligibility criteria or proveness criteria or any other requirement then bidder must prepare one single PDF file of all the related documents and then upload in the system in OID

Bid Opening Process is as below:-

Cover-I: Technical bid opening date will be as per given dates. If any clarification is needed from the bidder about the deficiency in his uploaded documents in Cover-I, he will be asked to provide it through Short fall documents folder in e-tendering portal. The bidder shall upload the requisite clarification / documents within time specified by HEC, failing which tender will be liable for rejection.

Cover-II: The financial bids of the contractors / firms found to be meeting the qualifying requirements and technical criteria shall be intimated through portal. (Depending on Cover-I evaluation any changes in the date shall be intimated through e-tendering portal).

12.0 Please read carefully before you quote: -

Last date of Receipt of Tender Document : by 1:00 PM (IST) on 28/01/2021
Due date of tender opening (Part 1 only) : at 3:00 PM (IST) on 29/01/2021

1. Items to be supplied as per the provided specifications.
2. It should be quoted on **FOR HMBP Store**.
3. **Validity** – Minimum 90 days from the date of opening of tender.
4. Order will be under L.D. clause.
5. Price Bid:-Price bid to be uploaded as per BOQ of NIT.
6. Commercial Terms and condition in Annexure-B to be submitted/uploaded along with Technical (part 1) bid.
7. In case bidder is covered under MSME criteria, it is mandatory to quote UAM No. in bid documents.
8. **Instruction to bidder:** “This procurement of goods/services under the reference tender is covered under Public Procurement Policy 2017 and PPC MSME 2012, revised 16.09.2020 and here in after any further revisions”.

- 13.0 **Disclaimer clause:-**The Company (Heavy Engineering Corporation Ltd.) nor the service provider (www.etenders.gov.in) is responsible for any failure of submission of bids due to failure of internet or other connectivity problems or reasons thereof.

1.0 SCOPE OF SUPPLY: -

Sl.	Drg. No.	Mat./Item Code	Desc.	Qty.
1	1040.18.029	4104018029	Felt Ring	1
2	1040.03.278	4104003278	Ferodo Brake Lining 58.5x90x8	2
3	1040.03.237	4104003237	Packing Ring	4
4	3200.02.254	4320002254	Seal for Jaure Barrel Coupling (model No: TCB-S 4200), Make-Jaure	1
5	4131.06.119	4413106119	Torsional Spring	1
6		3101043020	Gasket 8mm (ID1980mm X OD2170mm)	1
7		3101043030	Rubber (2x50x3500mm)	10
8		3101043040	Rubber (2x50x5250mm)	3
9		3102406190	Oil Seal A260x300x20	2
10		9330121850	Round Steel Short Link Chain, Link Dia 12.5mm, electric butt welded, L=1850 Calibrated, Material Grade-30 (Normalised), unpolished IS:2429-70(II). Minimum Break Load 7400Kgs.	2
11		3102406190	Oil Seal A260x300x20	2
12	1040.09.307	4104009307	Spring	6
13		9330121852	Link Chain, 12.5mm, L=1850 (Grade-30 Normalised polished IS:2429-70	1
14	1250.06.050	4125006050	Chevron Packing, make-Hunger / Markel / Busak-SHAMBAN / Jameswalker (Imported)	1
15	1040.09.648	4104009648	Packing (rubber)	1
16	1040.09.103	4104009103	Disc (Conveyer Belt)	4
17	1040.03.715	4104003715	Collerar dia 80 (hard rubber)	1
18	1040.03.237	4104003237	Felt Ring	4
19		4124001015	Rubber Packing t=1mm A=1m2	4
20		4012200161	Packing L=1300	8
21		4012200168	Packing L=3000	16
22		4012200160	Packing L=5500	8
23	1220.03.25	4012200325	Flexible Guard	8
24	1060.16.702	4106016702	Gasket (Permanite)	4
25	1060.16.729	4106016729	Gasket (Permanite)	1
26	1060.16.763	4106016763	Gasket (Permanite)	2
27	1060.16.764	4106016764	Gasket (Permanite)	2
28	1060.16.765	4106016765	Gasket (Permanite)	2
29	4301.16.802	4430116802	Gasket 85x70x1 (Permanite)	1
30			Gasket 22 (Copper DHP)	1
31	1040.18.648	4104018648	Packing	1
32	1040.18.650	4104018650	Collar Dia 250 (hard Rubber)	1
33	1040.18.653	4104018653	Inner Spring	1
34	1040.18.654	4104018654	Outer Spring	1
35		3101022020	Rubber Cord dia 5.8, L=725 (Oil resistente)	1
36	4301.16.811	4430119811	Spring wire dia 2mm	1
37	1004.19.49	4010041949	Felt Ring t=25	4
38	1004.19.65	4010041965	Felt Ring t=25	6
39	1004.19.49	4010041949	Felt Ring t=25	4
40	1004.19.65	4010041965	Felt Ring t=25	6

41		4012140534	Cord dia 35, L=4500 (oil resistance)	1
42		3115002030	Felt 1000x1000x6	2
43		3102406130	Oil Seal A190x220x15 (Syn.)	1

Note:-

The above items shall be procured in totality on package basis and L1 shall be decided considering all items at a time.

Commercial terms and conditions:-

1. Offers to be submitted on FOR HMBP Stores basis. The rate quoted shall be inclusive of all packing & forwarding, freight and transit insurance charges.
2. The Price quoted by the tenderer should be exclusive of GST. The rate and nature of GST applicable should be shown separately GST will be paid to the seller at the rate at which it is liable to be assessed or has actually been assessed on the date of supply provided the transaction of sale is legally liable to GST and within the delivery period.
3. The rates quoted must be firm and the offers made must remain open for acceptance for three months from the date of opening of the tender.
4. Quotations erased or over written are likely to be rejected unless all corrections are authenticated with the tenderer's signature.
5. Delivery –Within 15 days from the date of purchase order.
6. Payment Term: 100% payment with 100% GST through RTGS/Cheque will be made within 60 days of the receipt of supplies at destination duly inspected.
“The payment shall be made within 60 days of the receipt and acceptance of supplies at the destination. The rate of interest to be loaded on the firm for the payment term offered other than as specified in NIT for calculating landed cost to decide L-1 status will be 1% per month i.e. 12% per annum (Maximum)”
7. Full particulars i.e. specification, literature and / or drawing wherever applicable has to be submitted along with the quotation. The 'Brand' and 'Make' name must be indicated.
8. The Corporation does not pledge itself to accept the lowest or any tender and reserves to itself the right of accepting the whole or any part of tender or portion of the quantity offered and you shall supply the same at the rate quoted.
9. Supplies will be subject to Inspection by our Inspection wing / or inspection Agencies prescribed by us.
10. Order placed as a result of this tender will be subject to the Corporation's General Terms and Conditions of contract which can be down loaded from our website (www.hecltd.com).
11. Corporation reserves the right to call for and examine at any time the books of accounts and other documents and papers of the firm for the purpose of ascertaining whether any excess payments has been made or the firm likely to be received / received undue benefit out of execution of the particular contract.
12. The final quantity may vary at the time of finalization of tender, however the proper clarification / confirmation shall be taken from the firms.
13. Delivery: The time for and the date of delivery of the Stores stipulated in the acceptance of tender shall be deemed to be the essence of the contract and delivery must be completed not later than the dates specified therein.
 Otherwise:
 - a) **LD Clause** - The purchaser to recover from the contractor a sum of 0.5 % per week (completed week) of the price of the stores(upto maximum 10 %) as liquidated damages, which the contractor has failed to deliver as aforesaid or,
 - b) The purchaser may procure the undelivered stores / similar items from elsewhere, without notice to the contractor at the risk of the contractor without canceling the contract in respect of the consignment not yet due for delivery or,
 - c) to cancel the contract or a portion thereof.

14. Tenderers registered with National Small Industries Corporation/ Small Scale Industries/ Micro, Small scale Industry (MSE) or DGS&D for the tendered item will be exempted from submission of EMD. The tenderer should enclose an authenticated copy / notarized copy of their valid registration certificate with NSIC, DGS&D for grant of exemption.

In case Bidder is covered under MSME criteria, it is mandatory to quote UAM no in Bid Documents.

HEC is registered on TReDS governed by RBI Guidelines and our registration no is HE0000320. All MSME firms are advised to register on RXIL (Receivable exchange of India-Mumbai)

15. **Security Deposit (SD) (BG Format annexure D)** – Successful bidder has to deposit Security Deposit to the extent of 5% of total Purchase Order value within 21 days from P.O. date and it should remain valid for a period of 60 days beyond the date of completion of all contractual obligations of the supplier.

16. **Performance Bank Guarantee (PBG)** amounting 10% of the Contract value in the form of Bank Guarantee valid till guarantee period.

17. **Guarantee** – The stores supplied shall be guaranteed for a period of 12 months from date of use or 18 months from date of supply whichever is earlier.

18. Based on HEC's requirement and in order to ensure security of supply from one source, the total tendered quantity of any item may not be split amongst more than one successful bidder at L1 Landed price. Hence Purchase Order may be placed on one firm and the repeat order for 100% quantity may be placed on successful bidder.

19. **Risk Purchase Clause** – If the material is not supplied within the stipulated period then material can be procured at the risk & cost of the firm without giving any notice to the firm.

20. There is no obligation on our part to accept delayed / late tenders. Tenders received after the due date of opening are liable to be summarily rejected.

21. **General conditions of the contract** : Unless otherwise specified in the Terms & Conditions above, this order shall be governed by General conditions of contract of purchase of HEC Ltd, which is available in the web site of HEC. (www.hecltd.com).

22. **ARBITRATION**

• **RESOLUTION OF DISPUTE(s) by ARBITRATION** The parties to the contract at the first instance shall endeavor to settle by mutual discussion all the questions of disputes all differences arising out of , or relating thereto, all in connection with this contract In the event of failure of settlement , the aggrieved party with prior written permission of other party , shall refer the unresolved dispute(s) or differences(s) to the chairman-cum-managing director of the company(HEC) for adjudication by a sole arbitrator to be appointed with mutual consent by him (CMD of the company) who(sole arbitrator) shall adjudicate the matter in accordance with the arbitration and conciliation act ,1996 (For short "ACT") and publish the award. The party shall have no objection if the sole arbitrator so appointed is an Ex- Employee of HEC, superannuated almost three years ago from the date of reference .If the sole arbitrator for any reason , whatsoever , becomes unable to proceed with the arbitration , the chairman-CUMManaging Director of the company , with mutual consent of both the parties, shall appoint his successor arbitrator who may proceed with the reference from the stage it was left by the predecessor or subject to the provisions of the Act . The venue of the arbitration proceeding shall be at Ranchi in the State of Jharkhand alone. The other provisions of arbitration & Conciliation act , 1996 , (As amended from time to time) especially as per the provisions of schedule V and schedule VII and sections 6 , 11(2), 12(5) should be considered during the appointment of sole arbitrator .

• **Law Governing contract-** (1)This contract shall be governed by the laws of India for the being in force. (2)Irrespective of the place of delivery, the place of payment under the contract, the contract shall be deemed to have been made at the place from which the acceptance of tender has been issued. (3)Jurisdiction of Courts: For any or all types of disputes arising out of the contract, the exclusive jurisdiction of the court (s) shall be Ranchi in the State of Jharkhand alone. (4)Marking of Stores:

The marking of the stores must comply with the requirements of the laws relating to Merchandise Marks for the time being in force in India.

OTHER TERMS AND CONDITIONS

- Other terms and conditions which are not mentioned above shall be as per General Terms and Conditions of Contract of the Corporation which can be downloaded from our website (www.hecltd.com).
- This procurement of goods/services under the reference tender is covered under Public Procurement Policy 2017 and PPC MSME 2012, revised 16.09.2020 and here in after any further revisions.
- The Corporation does not pledge itself to accept the lowest or any tender and reserves to itself the right of accepting the whole or any part of tender or portion of the quantity offered and you shall supply the same at the rate quoted.
- While submitting tender pl. mention your Registration No. with HEC as a registered vendor with valid paper. If not pl. get registered your firm with HEC Limited immediately.
- Please indicate whether your firm covered under MSES/MSES owned SC/ST or covered under SSI separately in Techno-commercial bid.
- Please submit the form of Terms & Conditions (**Annexure B**) duly filled in and signed by the tenderer along with your offer in technical (part-1) bid.

(P.S. Paswan)
Manager (Purchase Deptt.)
Heavy Machine Building Plant
Heavy Engineering Corporation Limited
Dhurwa, Ranchi – Jharkhand (India)

Terms & Conditions:

Sl. No	Terms	HMBP/HEC Requirement	Bidders confirmation
1	Price Terms (F.O.R. HMBP) Inclusive of P & F charges, Freight and Insurance charges upto HMBP Stores Ranchi	FOR HMBP Stores	
2	GST	To be quoted separately indicating HSN no of material and GSTN of firm	
3	Payment Terms	100% payment along with 100% taxes will be made against tax invoice within 60 days after receipt of material at HMBP Stores duly inspected. For offered payment term other than as specified in NIT, interest @1%per month ie 12% per annum will be loaded on offered rate of the firm for calculating landed cost to decide L1 status	
4	Validity of offer	3 months.	
5	Price variation clause	Not applicable	
6	Delivery Schedule	Within 15 days from PO date.	
7	L D Clause	To be accepted	
8	Inspection	By QCA/HMBP at your works.	
9	Test Certificate and Guarantee Certificate	To be provided by manufacturer	
10	Guarantee / Warranty	12 months from the date of use or 18 months from the date of supply whichever is earlier.	
11	Security Deposit	5% of P.O. value	
12	PBG	10% of P.O. value	
13	UAM (Udyog Aadhar No) No if registered under MSME	To be mentioned by bidder if applicable	
14	Acceptance of Risk Purchase clause(yes/no)	To be accepted	
15	General conditions of the contract	To be accepted	
16	Exemption of EMD	Submission of SSI/NSCI/MSME and DGS&D certificate	
17	Please indicate whether your firm is covered under MSME/MSEs owned SC/ST or covered under SSI separately in Tech. Bid		

NOTE: 1. Please indicate whether your firm is covered under MSME/MSEs owned SC/ST or covered under SSI separately in Tech. Bid.

2. Terms & Conditions duly filled in and to be submitted along with Tech – Bid of offer otherwise your offer may not be evaluated.

Format for
BANK GUARANTEE FOR SECURITY DEPOSIT

(To be issued by any Nationalized bank preferably State bank of India negotiable at their counters in Ranchi)

TO,

M/S HEAVY ENGINEERING CORPORATION LIMITED
PLANT PLAZA ROAD,
DHURWA,
RANCHI – 4

Dear Sir,

In consideration of your agreeing to accept the security deposit of Rs.'amount'..... furnishable to you by m/s 'firms name'..... (hereinafter referred to as contractor) in terms of the contract no.'hec's purchase order no'.....for supply of 'details of items'.....(hereinafter referred to as the 'contract') in the form of a bank guarantee in the manner hereinafter contained we.....'bank details'..... branch, having registered office at 'place'..... do hereby covenant and agree with you as follows:

1. We hereby undertake to indemnify you up to a sum of rs.'amount'.....(rupees 'amount in words'.....) against any loss or damage caused to or suffered by you or that may caused to or suffered by you by reason of any breach or breaches on the part of the contractor of any of the terms and conditions contained in the said contract and in the event the contractor shall make any default or defaults in carrying out any of the works under the said contract or otherwise in the observance and performance of any of the terms and conditions relating thereto in accordance with the true intent and meaning thereof, we shall forthwith on demand and without any protest or demur pay to you such sum or sums not exceeding in total the said sum of Rs.'amount'.....(rupees 'amount in words'.....) as may be claimed by you as your losses and / or damages, costs, charges or expenses by reason of such default or defaults on the part of the contractor.
2. Notwithstanding anything to the contrary contained in this guarantee your decision as to whether the contractor has made any such default or defaults and the amount or amounts to which you are entitled by reasons thereof will be binding on us and we shall not be entitled to ask you to establish your claim or claims or damages or losses suffered by you but will pay the amount demanded by you under this guarantee forthwith on your demand without any protest or demur.
3. This guarantee shall continue and hold good until it is released by you on the application by the contractor after expiry of the related warranty period of the said contract and after the contractor have discharged all their obligations under

the said contract and produced a certificate of due completion of the work under the said contract and submitted a 'no demand certificate' provided always that this guarantee shall in no event remain in force after the date of ...'*date*'..... without prejudice to your claim or claims arisen and demanded from or otherwise notified to us in writing before the expiry of six months from the said date which will be enforceable against us notwithstanding that the same is or are enforced after the said date.

4. We'*bank name*'....., further undertake to extend the validity of this beyond the period prescribed in clause 3 or as extended from time to time, for such further period as may be required in writing before the expiry of this and upon such extension(s), all terms and conditions of this shall remain in full force till the expiry of this extended period(s).
5. You will have the fullest liberty without affecting this guarantee from time to time to vary any of the terms and conditions of the said contract or extend the time of performance of the contractor or to postpone for any time or from time to time any of your rights or powers against the contractor and either to enforce or forebear to enforce any of the terms and conditions of the said contract and we shall not be released from our liability under this guarantee by the exercise of your liberty with reference to matters aforesaid or by reason of any time being given to the contractor or any other forbearance, act or omission on your part or any indulgence by you to the contractor or by any other variation or modification of the said contract or any other act, matter or things whatsoever, which, under the law relating to sureties, would but for the provisions hereof, have the effect or so releasing us from our liability hereunder provided always that nothing herein contained will enlarge our liability hereunder beyond the limit of rs.'*amount*'.....(rupees'*amount in words*'.....) as aforesaid or extend the period of the guarantee beyond the said date of ...'*date*'.... unless expressly agreed to by us in writing in terms of clause 4 hereof.
6. This guarantee shall not in any way be affected by your taking or varying or giving up any securities from the contractor or any other person, firm or company on its behalf or by the winding up, dissolution, insolvency or death as the case may be of the contractor.
7. In order to give full effect to the guarantee herein contained, you shall be entitled to act as if we are your principal debtors in respect of all your claims against the contractor hereby guaranteed by us as aforesaid and we hereby expressly waive all our rights of suretyship and other rights, if any, which are in any way inconsistent with any of the provisions of this guarantee.
8. Subject to the maximum limit of our liability as aforesaid this guarantee will cover all your claim or claims against the contractor from time to time arising out of or in relation to the said contract and in respect of which your claim in writing is lodged on us before expiry of six months from the date of expiry of this guarantee.

9. Any notice by way of demand or otherwise hereunder shall be in writing and may be sent by special courier, speed post or telefax to us at our local address as aforesaid.
10. This guarantee and the powers & provisions herein contained are in addition to and not by way of limitation of or substitution for any other guarantee or guarantees heretofore given to you by us whether jointly with others or alone and now existing uncanceled and that this guarantee is not intended to and shall not revoke or limit such guarantee or guarantees.
11. This guarantee shall not be affected by any change in the constitution of the contractor or us nor shall it be affected by any change in your constitution or by any amalgamation or absorption thereof or therewith but will ensure for the benefit of and be available to and enforceable by the absorbing or amalgamated company or concern.
12. This guarantee is irrevocable during the period of its currency and shall not be revoked without your previous consent in writing.
13. We further agree and undertake to pay you the amount demanded by you in writing irrespective of any dispute or controversy between you and the contractor or any reference to arbitration of the said dispute / controversy pending or a civil suit filed by the contractor in respect of the dispute or controversy.
14. Notwithstanding anything contained herein above our liability under this guarantee is restricted to Rs.'amount'.....(rupees*'amount in words'*.....) and this guarantee shall remain in force until*'date'*.... unless a written claim is lodged on us for payment under this guarantee within six months from the date of expiry of this guarantee i.e. on or before ...*'date'* + *'6 month'*..... all your rights under this guarantee shall be forfeited and we shall be deemed to have released and discharged from all liabilities thereunder. Irrespective of whether or not the original guarantee is returned to us.
15. We have power to issue this guarantee in your favor under the memorandum and articles of association of the bank and the undersigned has full power to execute this guarantee under the power of attorney granted to them by the bank.

FOR AND ON BEHALF OF

'Name of bank'

'Signature with seal'

872800401

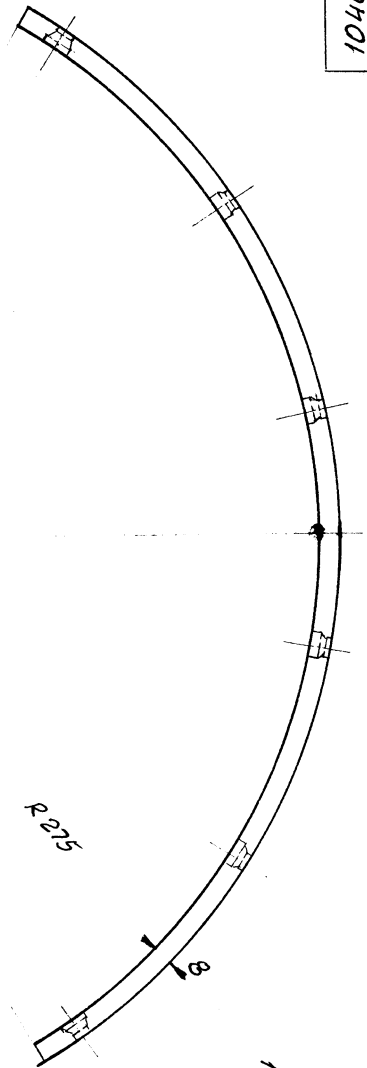

Technical Instruction
 1. 12 holes ϕ 8.5 should be drilled in accordance with friction shoe dry. no. 104003276

Development

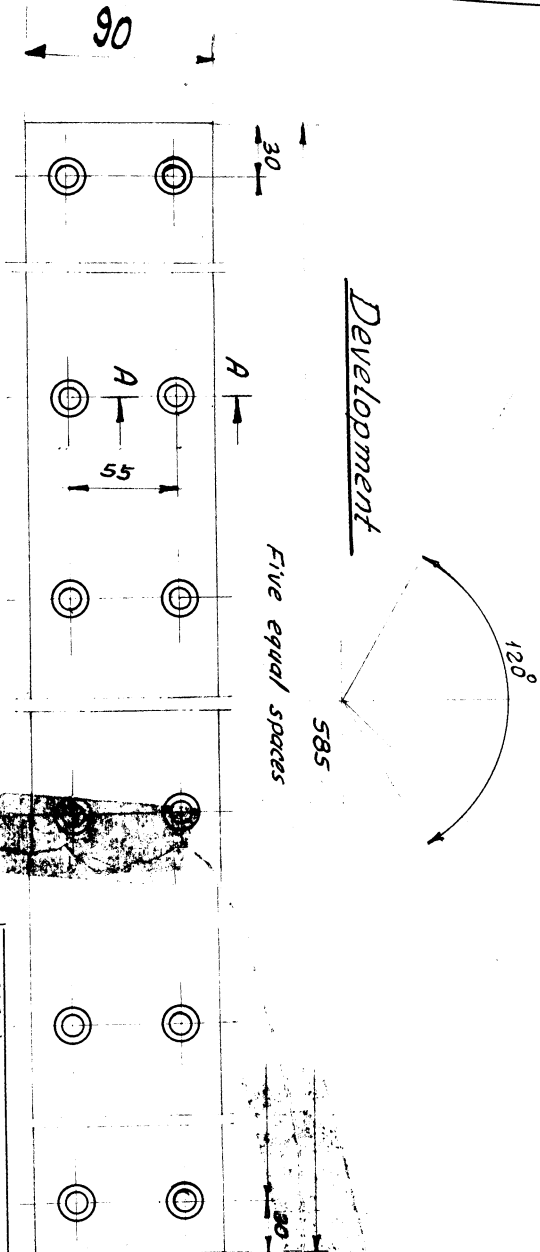

Section A-A

Scale 2:1

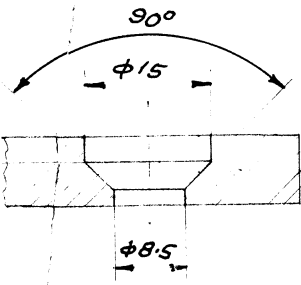

Index	Revision	Signature	Date
1			

104003257

Ferodo Brake Lining
 585 x 90 x 8

104003251
 Ref. Des. No.

Bureau Chief	H. Singh
Group Leader	R. Khanna
Designer	D. B. Singh
Drawn by	Asst. Engr.
Exam. Confd.	

Scale: 1:2

HMB
 H. E. C. LTD., RANCHI

Material: F4700/084
 Weight in kg.: 0.81

104003278

REVALIDATED
 Bureau: Ex-T/ME
 Sig & Dt: WPS 15-1-78
 12-11-78

10-3-2871

1220.03.25

Form 117

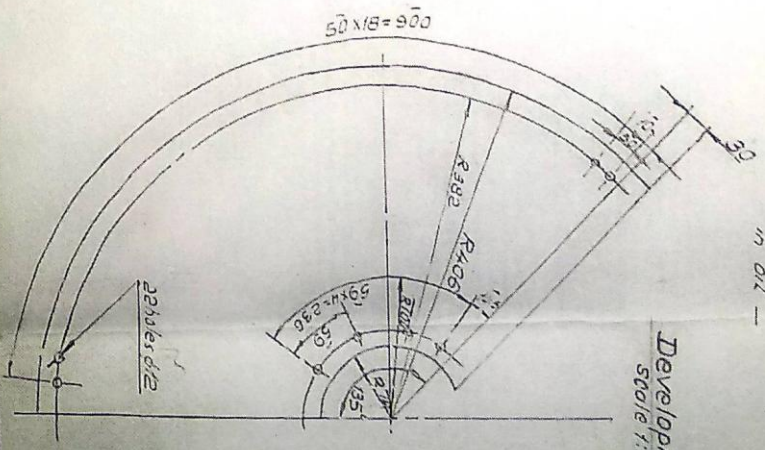
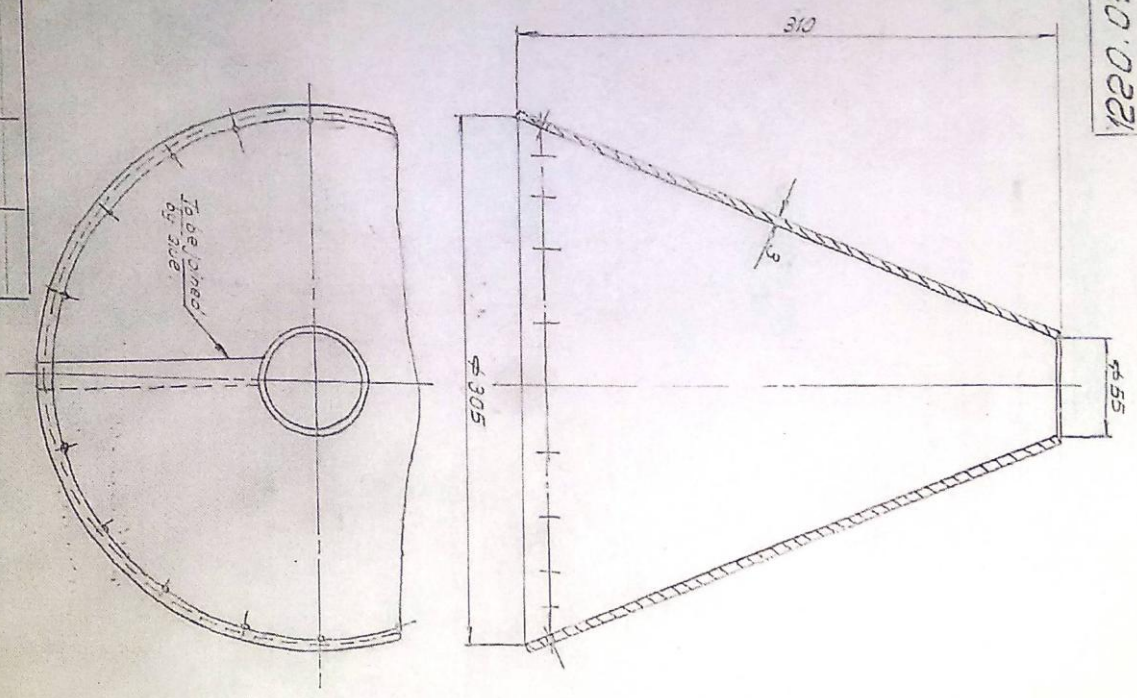

Technical Instructions

1. Mark on tag
2. The rubber should have the following properties -
 - (a) Elongation - Not less than 300%
 - (b) Residual Elongation - Not more than 40%
 - (c) Swelling by weight - in oil - Not more than 3%

Development
Scale 1:1.5

1220 11-79

Index	No.	Revisions	Signature	Date

3-183077

1220.03.01A

Ref. Dwg. No.

Norm. Cont.

Flexible Guard

Bureau Chief	B. S. Srinivasa	B. L. V. S.
Group Leader	D. K. Saha	D. L. V. S.
Designer	N. K. Thakur	M. S. S. S.
Drawn by	M. S. S. S.	M. S. S. S.

Scale: 1:1.5

Material: Rubber type 15 638-79

1220.03.25

Aug 65

HMB

H. E. C. LTD. BANGHI

Rev. 0

0.25 A

050900521

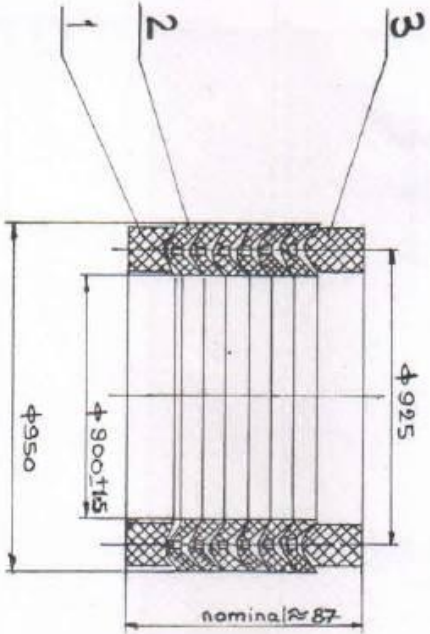

Technical Instruction

1. Packings are to be manufactured from rubber graphite mixture reinforced bilaterally with cotton fabric.
2. Bonding strength between each fabric layer after manufacture should not be less than 1 kgf. in a thickness of 1 cm.
3. Working surfaces of the packing and rings should be smooth without wrinkles, burrs, cracks and blisters. Non-working surfaces, are allowed to have indentations and risings not more than 1mm in height, moulding impressions not affecting the quality of working over the area not more than 0.5 cm².
4. Chevron packing to be suitable for a test pressure of 130 kg/cm².
5. Working Pressure - - - 65 kg/cm²
Working Fluid - - - Hydraulic oil.
6. Temp (Maximum) - - - 70°C
The manufacturer/Supplier should furnish certificate for the compliance to the present requirement.

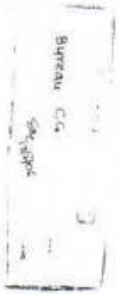

(re-iterated by:)

Order No.	Revision	Signature	Date

Process: (Name) (Date)

Working: (Name) (Date)

Check: (Name) (Date)

Item No.	DWG. No.	Description	Material	No. off	Net Wt. in Kg	Total Remarks
3	125006052	Chevron packing 900 x 950 (Supporting pieces)	1	0.51	0.51	
2	125006052	Chevron packing 900 x 950	6	1.5	9.0	
1	125006052	Chevron packing 900 x 950 (Thrust piece)	1	2.02	2.02	

Chevron Packing

125006050

Weight: Kg: 14.93

Order made by: J. S. Singh

Design made by: D. N. Pathak

Checked by: S. P. Singh

Signature: S. P. Singh

Company: HMB

Address: H.E.C. LTD., RANCHI

Rev: 0

12-3-1976

3200.02.254

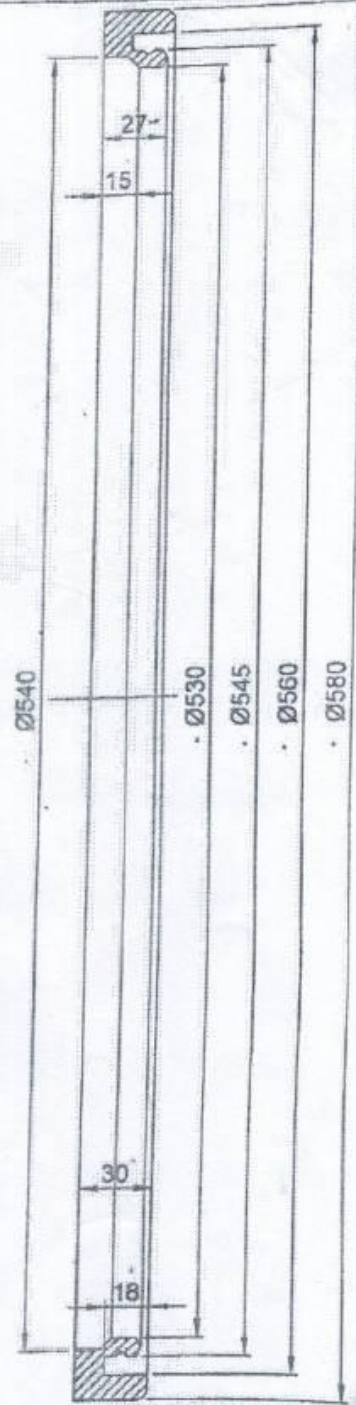

Note:-

- a) The dimension mentioned in drawing is only for reference purpose.
- b) The seal shall be exact replacement for Barrel Coupling TCB-S 4200 Supplied by M/s Jaure against P.O. no. HMB/CED/PUR/99/04/09/004/PO/023, dtd- 10.04.2010

 एच.ई.सी.	Seal for Barrel Coupling Mode no. TCB-S-4200 of JAURE			3200.02.254	
				MATERIAL- Rubber	
BUREAU CHIEF	R. J. PRASAD	<i>[Signature]</i>	SCALE: 1:2.5	WEIGHT IN KG.- 0.10	
GROUP LEADER	M. HELAL	<i>[Signature]</i>	H.M.B. HEC LTD., RANCHI		
DESIGNER	SUNIL KUMAR	<i>[Signature]</i>			
DRAWN BY	TUNEB KUMAR	<i>[Signature]</i>	Rev-0		
REF. DRS. NO.					

4131.06.119

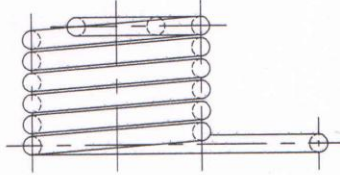
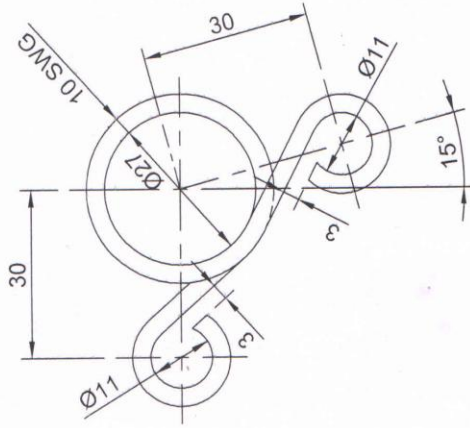

Ref- DAP 130/20 M

Spring Data

Pitch = 4.06
Dia. of Wire = 10 S.W.G. (3.251 mm)
Free Length = 27.61
Active Coils = 5

एच. ई. सी.



5.07135
4131.06.100
REF.DRG.NO.

Torsional Spring

4131.06.119

Hard Drawn Spring Steel
MAT.:- SAE 1065

BUREAU-CHIEF	D.Ojha	SCALE - 1:1	WEIGHT IN KG - 0.06
CHECKED BY	D.Ojha		
DESIGNED BY	P.K.Singh		June 20
DRAWN BY	S.Ekka		Rev-0
		H.M.B.	
		HEC LTD., RANCHI	

4301-16-811

When deflection is 26 mm.

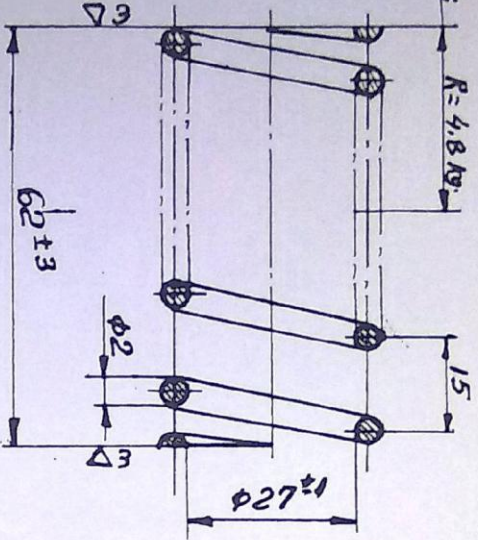

No. of Working coils	4
Total no. of coils	5.5
Wire length	507
Special tests	

Technical Requirements

- 1 End faces should be square with spring axis within 3 mm. (when checked with a square)
2. Marks on tag.

Compared with original.

OK
11/5/84
E. S. Das
L. H. Das

Index	No.	Revision	Signature	Date

Spring wire dia 2 mm.

Business Order	N.K. Saha
Group Leader	A. Sharma
Engineer	R. Sharma
Drawn by	R. Sharma
Sign. Dept.	

Ratio	1:1
Material	Steel Gr. 2
Weight in kg.	15.41954-67
H M B	
H. E. O. LTD., RAIPUR	

4301.16.811

July '70

by: A.K. Singh (29.3.84)

43-4-2483

43-4-2483

43-4-2483

620.81.0401

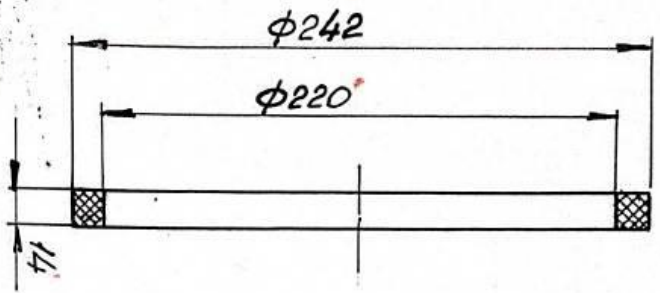

Tie tag with marking.

REVALIDA:LO
Bureau ... R.G.
Sig & Dt [Signature] 18/96

Index	No.	Revision	Signature	Date

1006.18.129	Felt Ring			1040.18.029
	Bureau Chief	S. BASU	<i>[Signature]</i>	Material: Felt
	Group Leader	R. K. K. K.	<i>[Signature]</i>	
	Designer	A. N. Venma	<i>[Signature]</i>	
	Drawn by	A. S. Singh	<i>[Signature]</i>	
	Norm. Cont.			
1040.18.025	Scale: 1:2.5	H. E. C. LTD., RANCHI		Weight in kg 0.04
Ref. Dtg. No.		H. M. B.		July '84

10-5893