



ISO 9001 Company

**Heavy Engineering Corporation Limited**  
(A Govt. of India Enterprise)  
Heavy Machine Building Plant  
Ancillary & Contract Department

No. ACD/HMB/20/FAB/2140/OTE-6108

Date: 02/09/2020

## **OPEN TENDER ENQUIRY**



### **Procurement of Side Platform (LH & RH)**

Tender on sale	:	up to 23/09/2020 upto 5:00 PM
Schedule of Tender receipt	:	24/09/2020, upto 1:00 PM
Opening of tender	:	24/09/2020 at 3:00 PM

#### **Submission of offer**

The complete tender is to be submitted in a separate sealed envelope super scribing the tender no., before the scheduled date of submission of tender in the tender box at the office of ACD/ HMBP, Room no. 28, HMBP ADM Building, HEC Ltd, Ranchi 4. If the tender is bulky & voluminous the tenders are to be submitted at office of MM/HMBP

#### **The offer has to be given in two part bids.**

- (A) Part-I of the offer will contain the technical and commercial aspects as per Annexure 1 in the enquiry. The duly filled Annexure 1 along with all documents (PO copy, Manufacturing Facilities, EMD, Tender Fee, Exemption Certificate etc.) will form Part-I of the offer. All above documents should be kept in one envelope and super scribe name of the enquiry and "Techno-Commercial Bid (Part-I)" over the envelope.
- (B) Part-II of the offer will contain Price Bid which is to be given in the format as per Annexure 2 of the enquiry. This price bid should be kept in a separate envelope and super scribe name of the enquiry and "Price Bid (Part-II)" over the envelope.

Both the above sealed envelopes should be kept in one single envelope and super scribe name of the enquiry, opening date and mention part I & II over this envelope.

**Part (I) and Part (II) should be strictly submitted in the format as given in this enquiry as Annexure – 1 and Annexure – 2 respectively.**

**Future changes/notifications/Corrigendum including extension of bid due date if any, pertaining to this tender will be published/hosted only on HEC website/CPP Portal.**



ISO 9001 Company

**Heavy Engineering Corporation Limited**  
(A Govt. of India Enterprise)  
Heavy Machine Building Plant  
Ancillary & Contract Department

No. ACD/HMB/20/FAB/2140/OTE-6108

Date: 02/09/2020

**(A) Scope of Supply:**

HEC intends to procure the "Side Platform LH & RH". Interested firms are requested to submit their most competitive offer for supply of following item as per the technical Instructions and the terms & conditions given below.

Sl. No.	Drg.No.	Desc.	Set	Wt per set (Kg)	Material Grade
1	1050.07.500	Side Platform (LH)	05	947.00	As per Drgs
2	1050.07.510	Side Platform (RH)	05	1191.00	As per Drgs

**(B) Technical Instructions:**

1. Items are to be supplied as per HEC drawings and its technical instructions.
2. Items should be of good surface finish as per HEC drawing and free from any defect.

Note - Drawings are enclosed with the NIT & detailed drawings are available in our office (ACD)/HMBP, HEC Ltd. for study on any working day before opening of tender.

**Terms & Conditions**

1. The rate quoted shall be Inclusive of all packing & forwarding, Freight charges & insurance on F.O.R HMBP Stores.
2. The Price quoted by the tenderer should be exclusive of GST. The rate and nature of GST applicable should be shown separately. GST will be paid to the seller at the rate at which it is liable to be assessed or has actually been assessed on the date of supply provided the transaction of sale is legally liable to GST and within the delivery period.
3. **Validity of offer** - The rates quoted must be firm and the offer made must remain valid for acceptance up to **three months** from the date of opening of the tender. The rate quoted must be in word and figure as well. In case any discrepancy in rate given in figures and word, the rate given in words will prevail.
4. **Payment terms:** 90% payment along with 100% taxes and duties within two months of receipt of material in HMBP and 10% against C.R.V (to be issue by our Stores after receipt and acceptance of material at HMBP). In case of any deviation by the bidders necessary loading @ 1% Per Month (12% max Per Year) on quoted price shall be applicable and L-1 firm will be decided based on landed cost after loading on quoted price.
5. **Delivery Schedule –**
  - A. 1<sup>st</sup> set **within one month from the date of issue of PO.**
  - B. 2<sup>nd</sup> set **within two month from the date of issue of PO.**
  - C. 3<sup>rd</sup> & 4<sup>th</sup> sets **within three month from the date of issue of PO.**
  - D. 5<sup>th</sup> set **within four month from the date of issue of PO.**
6. Full particular i.e. specification, literature and or drawing wherever applicable should be submitted along with the quotation.



ISO 9001 Company

**Heavy Engineering Corporation Limited**  
(A Govt. of India Enterprise)  
**Heavy Machine Building Plant**  
**Ancillary & Contract Department**

---

7. The Corporation does not pledge itself to accept the lowest or any tender and reserve to itself the right of accepting the whole or any part of tender or portion of the quantity offered and you shall supply the same at the rate quoted.
8. Inspection of the manufactured items will be done by QCA/HMBP or his authorized representative at supplier's works, Necessary tools and measuring instruments to be provided by the supplier.
9. Corporation reserves the right to call for and examine at any time the books of accounts and other document and papers of the firm for the purpose of ascertaining whether any excess payment has been made or the firm likely to be received / received undue benefit out of execution of the particular contract.
10. **Earnest Money Deposit -Rs 5,000/-** will have to be deposited by demand draft on any of the nationalized banks in favor of "Heavy Engineering Corporation Limited, payable at Ranchi" or in the form of Bank Guarantee as per annexure. EMD in form of DD/BG will have to enclose in the Techno- Commercial bid (Part I). Exemption of EMD shall be applicable on submission of valid SSI/NSIC/MSME certificate and as per prevailing govt guidelines. SSI/NSIC/MSME Certificate to be enclosed in Techno Commercial Bid Part I.
11. **Tender Fee (Non Refundable) –Rs 200/-** will have to be deposited by demand draft on any of the nationalized banks in favor of "Heavy Engineering Corporation Limited, payable at Ranchi. The copy of Tender Fee in form of DD will have to enclose in the Techno- Commercial bid (Part I). Exemption of Tender Fee shall be applicable on submission of valid SSI/NSIC/MSME certificate and as per Govt rules. SSI/NSIC/MSME Certificate to be enclosed in Techno Commercial Bid Part I.
12. **Security deposit (SD)** – Successful tenderers will have to deposit security equal to 5 % of the value of the contract within the desired period i.e. within 21 days of PO date. Failing this, the contract will be cancelled at the risk and expenses of the suppliers. SD will have to be deposited by demand draft on any of the nationalized banks in favor of "Heavy Engineering Corporation Limited, payable at Ranchi" or in the form of Bank Guarantee as per Annexure.
13. Delivery : The time for and the date of delivery of the Stores stipulated in the acceptance of tender shall be deemed to be the essence of the Contract and delivery must be completed not later than the dates specified therein. Otherwise:
  - a. The purchaser to recover from the Contractor a sum of 0.5% per week (Completed week) of the price of the Stores (upto maximum 10%) as liquidated damages, which the contractor has failed to deliver as aforesaid or
  - b. The purchaser may procure the undelivered stores/ similar items from elsewhere, without notice to the contractor at the risk of the contractor without canceling the contract in respect of the consignment not yet due for delivery or
  - c. To cancel the contract or a portion thereof.
14. There is no obligation on our part to accept delayed / late tenders. Tenders received after the due date of opening are liable to be summarily rejected.
15. The rates quoted shall also be inclusive of embossing on the material. The ownership namely HMBP should be at a predominant place of the material to a size/ thickness upon the volume of the material.
16. The corporation reserves the right to reject any / all tender partly / fully and no tenderer can ask any explanation anywhere in this regard.
17. Successful Bidders have to sign the confidentially agreement in HEC's format.



ISO 9001 Company

**Heavy Engineering Corporation Limited**  
(A Govt. of India Enterprise)  
**Heavy Machine Building Plant**  
**Ancillary & Contract Department**

---

18. **Guarantee clause-** The items supplied shall be guaranteed for a period of 12 months from the date of commissioning or 18 months from the date of delivery whichever is earlier against defective materials or bad workmanship
19. The repeat order for 100% quantity may be placed on successful bidder/bidders within one year from the date of delivery of the original Purchase Order on mutual agreement.
20. Based on HEC's requirement and as per TCC Recommendation, the total Tendered Quantity may be split amongst more than one successful bidder at L-1 Landed Price in the ratio of 60:40.
21. Order placed as a result of this tender will be governed by the Corporation's General Terms and Conditions of Contract which can be referred in HEC's website [www.hecltd.com](http://www.hecltd.com)

**Note:-**

1. As per the govt. Guidelines it is to be specified clearly in your offer whether your firm is registered with SSI/NSIC/MSME and also confirm whether the firm is owned by SC/ST Entrepreneurs or not.
2. Pl. provide UAM no to avail Facilities of MSME.
3. Please get registered your firm with HEC Ltd.

(S.K. Singh)  
DGM/ACD/HMBP  
FOR AND ON BEHALF OF HEC Ltd.



ISO 9001 Company

**Heavy Engineering Corporation Limited**  
(A Govt. of India Enterprise)  
**Heavy Machine Building Plant**  
**Ancillary & Contract Department**

**Annexure – 1**

PART – I (Techno - Commercial Bid)

**No. ACD/HMB/20/FAB/2140/OTE-6108**

**Date: 02/09/2020**

Quotation No.....

Sl.No.	Requisite		Remark
1	Whether the scope of Supply (A) & technical instruction (B) mentioned in the tender enquiry is acceptable.	Yes / No	
2	Reference & Photocopies of Major PO's placed on you by HEC /Other companies for same/similar items.	Yes / No	(enclose the relevant documents)
3	Duly notarized/Self Attested copies of Manufacturing Facilities available at your works for the same work/similar work.	Yes / No	(enclose the relevant documents)
4	Whether SSI/NSIC/MSME (For exemption of Tender Fee and EMD only), Also mention UAN No.....	Yes / No	(enclose the relevant documents)
5	Whether EMD & Tender Fee deposited (As per clause 10 & 11 of Terms & conditions)	Yes / No	(enclose the copy of DD/ BG)
6	F.O.R. HMBP (As per clause 1 of Terms & condition)	Yes / No	
7	Payment Term(As per clause 4 of Terms & condition)	Yes / No	(In case your answer is No, then please mention your term)
8	Delivery Term(As per clause 5 of Terms & condition)	Yes / No	(In case your answer is No, then please mention your term)
9	Validity (As per clause 3 of Terms & conditions)	Yes / No	
10	L.D. Clause(As per clause 13(a) of Terms & conditions)	Yes / No	
11	Risk Purchase Clause (As per clause 13(b) of Terms & conditions)	Yes / No	
12	Guarantee Clause (As per clause 18 of Terms & conditions)	Yes / No	
13	Security Deposit (As per clause 12 of Terms & conditions)	Yes / No	
14	GST Registered	Yes / No	GST rate.....
15	Inspection Clause (As per clause 8 of Terms & conditions)	Yes / No	
16	Firm is owned by SC/ST Entrepreneurs	Yes / No	
17	Whether Terms & Condition/Note etc. mentioned in the tender enquiry is acceptable to the tenderer	Yes / No	
18	Contact person Name: Email: Contact number:		

**Note :** In case of non-submission / submission of incomplete documents, your offer may not be considered for the said Enquiry.

(Signature of Tenderer)  
With official Seal



ISO 9001 Company

**Heavy Engineering Corporation Limited**  
(A Govt. of India Enterprise)  
**Heavy Machine Building Plant**  
**Ancillary & Contract Department**

**Annexure – 2**

PART-II (Price Bid)

No. ACD/HMB/20/FAB/2140/OTE-6108

Date: 02/09/2020

Quotation No.....

To,

The DGM  
Ancillary & Contract Department  
HMBP, HEC Ltd.  
Ranchi- 834004

Dear Sir,

In response to your enquiry for supply of following items. We give herewith our best offer without any deviation or rebate:-

Sl. No.	Drg.No.	Desc.	Wt/set in Kg	Set	Basic Rate in Rs /Set (FOR HMBP Stores)	
					In Figures	In word
1	1050.07.500	Side Platform (L.H.)	947.00	5		
2	1050.07.510	Side Platform (R.H.)	1191.00	5		

GST .....(Rate in %)

(Name of the Tenderer with Official Seal)

Important Note: -

1. Rate must be given in figure as well as in words.
2. Over writing in tender will not be accepted.
3. L-1 will be decided on the basis of individual item.
4. Note that the quantities and rates should be indicated both in figures, as well as in words. In case of any ambiguity, the writing in words will be considered. In case where amount written after multiplication of rate and quantity and there is some error, the total value or calculated value with rate whichever is lower to be considered.



ISO 9001 Company

**Heavy Engineering Corporation Limited**  
(A Govt. of India Enterprise)  
**Heavy Machine Building Plant**  
**Ancillary & Contract Department**

**Annexure 3**

Format for

**BANK GUARANTEE FOR EARNEST MONEY DEPOSIT**

*(to be issued by any Nationalized bank preferably State bank of India negotiable at their counters in Ranchi )*

NO.

Dated:

TO  
M/S HEAVY ENGINEERING CORPORATION LIMITED  
PLANT PLAZA ROAD,  
DHURWA,  
RANCHI – 4

Dear Sirs,

In consideration of your agreeing to accept the Earnest money deposit of Rs.-----  
(Rs----- ) furnishable to you by M/s-----  
------(Hereinafter  
Referred to As Contractor) In terms of the Enquiry No. -----  
-----Dtd. ----- for Supply of ----- (Hereinafter  
Referred to as the Contract) in the form of a Bank Guarantee in the Manner hereinafter  
contained we -----, having registered office at ----  
-----do hereby covenant and agree with you as follows.

1. We hereby undertake to indemnify you up to a sum of Rs. ----- (Rs. -----  
----- only) against any loss or damage caused to or suffered by you or  
that may be caused to or suffered by you by reason of any breach or breaches on the part  
of the contractor of any of the terms and conditions contained in the said contract and in  
the event the Contractor shall make any default or defaults in carrying out any of the  
works under the said contract or otherwise in the observance and performance of any of  
the terms and conditions relating thereto in accordance with the true intent and meaning  
thereof, we shall forthwith on demand and without any protest or demur pay to you such  
sum or sums not exceeding in total the said sum of Rs.----- (Rs. -----  
*amount*-----only) as may be claimed by you as your losses and/or damages,  
costs, charges or expenses by reason of such default or defaults on the part of the  
contractor.

2. Notwithstanding anything to the contrary contained in this guarantee your decision as  
to whether the contractor has made any such default or defaults and the amount or  
-----



ISO 9001 Company

**Heavy Engineering Corporation Limited**  
(A Govt. of India Enterprise)  
**Heavy Machine Building Plant**  
**Ancillary & Contract Department**

---

amounts to which you are entitled by reasons thereof will be binding on us and we shall not be entitled to ask you to establish your claim or claims or damages or losses suffered by you but will pay the amount demanded by you under this guarantee forthwith on your demand without any protest or demur.

3. This guarantee shall continue and hold good until it is released by you on the application by the contractor after expiry of the related warranty period of the said contract and after the contractor have discharged all their obligations under the said contract and produced a certificate of due completion of the work under the said contract and submitted a "NO Demand Certificate" provided always that this guarantee shall in no event remain in force after the date of----- without prejudice to your claim or claims arisen and demanded from or otherwise notified to us in writing before the expiry of six months from the said date which will be enforceable against us not withstanding that the same is or are enforced after the said date.

4. We-----, further undertake to extend the validity of this beyond the period prescribed in clause 3 or as extended from time to time for such further period as may be required in writing before the Expiry of this and upon such extension(s), all terms and conditions of this shall remain in full force till the expiry of this extended period(s).

5. You will have the fullest liberty without affecting this guarantee from time to time to vary any of the terms and conditions of the said contract or extend the time of performance of the contractor or to postpone for any time or from time to time any of your rights or powers against the contractor and either to enforce or forbear to enforce any of the terms and conditions of the said contract and we shall not be released from our liability under this guarantee by the exercise of your liberty with reference to matters aforesaid or by reason of any time being given to the contractor or any other forbearance, act or omission on your part or any indulgence by you to the contractor or by any other variation or modification of the said contract or any other act, matter or things whatsoever, which, under the law relating to sureties, would but for the provisions hereof, have the effect of so releasing us from our liability hereunder provided always that nothing herein contained will enlarge our liability hereunder beyond the limit of Rs. ----- (Rs. -----) as aforesaid or extend the period of the guarantee beyond the said Date of ----- unless expressly agreed to by us in writing in terms of clause 4 hereof.

6. This guarantee shall not in any way be affected by your taking or varying or giving up any securities from the contractor or any other person, firm or company on its behalf or by the winding up, dissolution, insolvency or death as the case may be of the contractor.

7. In order to give full effect to the guarantee herein contained, you shall be entitled to act as if we are your principal debtors in respect of all your claims against the contractor hereby guaranteed by us as aforesaid and we hereby expressly waive all our rights of suretyship and other rights, if any, which are in any ways inconsistent with any of the provisions of this guarantee.





ISO 9001 Company

**Heavy Engineering Corporation Limited**  
(A Govt. of India Enterprise)  
**Heavy Machine Building Plant**  
**Ancillary & Contract Department**

---

8. Subject to the maximum limit of our liability as aforesaid this guarantee will cover all your claim or claims against the contractor from time to time arising out of or in relation to the said contract and in respect of which your claim in writing is lodged on us before expiry of six months from the date of expiry of this guarantee.
9. Any notice by way of demand or otherwise hereunder shall be in writing and may be sent by special Courier or Telefax to us or our Local Address as aforesaid.
10. This guarantee and the powers & provisions herein contained are in addition to and not by way of limitation or substitution for any other guarantee or guarantees heretofore given to you by us whether jointly with others or alone and now existing uncanceled and that this guarantee is not intended to and shall not revoke or limit such guarantee or guarantees.
11. This guarantee shall not be affected by any change in the constitution of the contractor or us nor shall it be affected by any change in your constitution or by any Amalgamation or absorption thereof or therewith but will ensure for the benefit or and be available to and enforceable by the absorbing or amalgamated company or concern.
12. This guarantee is irrevocable during the period of its currency and shall not be revoked without your previous consent in writing.
13. We further agree and undertake to pay you the amount demanded by you in writing irrespective of any dispute or controversy between you and the contractor or any reference to arbitration of the said dispute/controversy pending or a civil suit filed by the contract or in respect of the dispute or controversy.
14. Notwithstanding anything contained herein above our liability under this guarantee is restricted to Rs.----- (Rs. -----only) and this guarantee shall remain in force until -----unless a written claim is lodged on us for payment under this guarantee within six months from the date of expiry of this guarantee . i.e. On or before-----all your rights under this guarantee shall be forfeited and we shall be deemed to have released and discharged from all liabilities there under, irrespective of whether or not the original guarantee is returned to us.
15. We have power to issue this guarantee in your favour under the memorandum and articles of association of the bank and the undersigned has full power to execute this guarantee under the power of Attorney Granted to them by the Bank.

FOR AND ON BEHALF OF



ISO 9001 Company

**Heavy Engineering Corporation Limited**  
(A Govt. of India Enterprise)  
**Heavy Machine Building Plant**  
**Ancillary & Contract Department**

---

**Annexure 4**

**Format for  
BANK GUARANTEE FOR SECURITY DEPOSIT**

( to be issued by any Nationalized bank preferably State bank of India negotiable at their counters in Ranchi )

TO,

M/S HEAVY ENGINEERING CORPORATION LIMITED  
PLANT PLAZA ROAD,  
DHURWA,  
RANCHI – 4

Dear sir,

In consideration of your agreeing to accept the security deposit of rs. ....'amount'..... furnishable to you by m/s ..... 'firms name'..... (hereinafter referred to as contractor) in terms of the contract no. ....'hec's purchase order no'.....for supply of ..... 'details of items'.....(hereinafter referred to as the 'contract' ) in the form of a bank guarantee in the manner hereinafter contained we.....'bank details'..... branch, having registered office at ..... 'place'..... do hereby covenant and agree with you as follows:

1. We hereby undertake to indemnify you up to a sum of rs. ....'amount'.....(rupees ..... 'amount in words'.....) against any loss or damage caused to or suffered by you or that may caused to or suffered by you by reason of any breach or breaches on the part of the contractor of any of the terms and conditions contained in the said contract and in the event the contractor shall make any default or defaults in carrying out any of the works under the said contract or otherwise in the observance and performance of any of the terms and conditions relating thereto in accordance with the true intent and meaning thereof, we shall forthwith on demand and without any protest or demur pay to you such



ISO 9001 Company

**Heavy Engineering Corporation Limited**  
(A Govt. of India Enterprise)  
**Heavy Machine Building Plant**  
**Ancillary & Contract Department**

---

sum or sums not exceeding in total the said sum of rs. ....'amount'.....(rupees ..... 'amount in words'.....) as may be claimed by you as your losses and / or damages, costs, charges or expenses by reason of such default or defaults on the part of the contractor.

2. Notwithstanding anything to the contrary contained in this guarantee your decision as to whether the contractor has made any such default or defaults and the amount or amounts to which you are entitled by reasons thereof will be binding on us and we shall not be entitled to ask you to establish your claim or claims or damages or losses suffered by you but will pay the amount demanded by you under this guarantee forthwith on your demand without any protest or demur.
3. This guarantee shall continue and hold good until it is released by you on the application by the contractor after expiry of the related warranty period of the said contract and after the contractor have discharged all their obligations under the said contract and produced a certificate of due completion of the work under the said contract and submitted a 'no demand certificate' provided always that this guarantee shall in no event remain in force after the date of ...'date'..... without prejudice to your claim or claims arisen and demanded from or otherwise notified to us in writing before the expiry of six months from the said date which will be enforceable against us notwithstanding that the same is or are enforced after the said date.
4. We ..... 'bank name'....., further undertake to extend the validity of this beyond the period prescribed in clause 3 or as extended from time to time, for such further period as may be required in writing before the expiry of this and upon such extension(s), all terms and conditions of this shall remain in full force till the expiry of this extended period(s).
5. You will have the fullest liberty without affecting this guarantee from time to time to vary any of the terms and conditions of the said contract or extend the time of performance of the contractor or to postpone for any time or from time to time any of your rights or powers against the contractor and either to enforce or forebear to enforce any of the terms and conditions of the said contract and we shall not be released from our liability under this guarantee by the exercise of your liberty with reference



ISO 9001 Company

**Heavy Engineering Corporation Limited**  
(A Govt. of India Enterprise)  
**Heavy Machine Building Plant**  
**Ancillary & Contract Department**

---

to matters aforesaid or by reason of any time being given to the contractor or any other forbearance, act or omission on your part or any indulgence by you to the contractor or by any other variation or modification of the said contract or any other act, matter or things whatsoever, which, under the law relating to sureties, would but for the provisions hereof, have the effect or so releasing us from our liability hereunder provided always that nothing herein contained will enlarge our liability hereunder beyond the limit of rs. ....'amount'.....(rupees ..... 'amount in words'.....) as aforesaid or extend the period of the guarantee beyond the said date of ...'date'... unless expressly agreed to by us in writing in terms of clause 4 hereof.

6. This guarantee shall not in any way be affected by your taking or varying or giving up any securities from the contractor or any other person, firm or company on its behalf or by the winding up, dissolution, insolvency or death as the case may be of the contractor.
7. In order to give full effect to the guarantee herein contained, you shall be entitled to act as if we are your principal debtors in respect of all your claims against the contractor hereby guaranteed by us as aforesaid and we hereby expressly waive all our rights of suretyship and other rights, if any, which are in any way inconsistent with any of the provisions of this guarantee.
8. Subject to the maximum limit of our liability as aforesaid this guarantee will cover all your claim or claims against the contractor from time to time arising out of or in relation to the said contract and in respect of which your claim in writing is lodged on us before expiry of six months from the date of expiry of this guarantee.
9. Any notice by way of demand or otherwise hereunder shall be in writing and may be sent by special courier, speed post or telefax to us at our local address as aforesaid.
10. This guarantee and the powers & provisions herein contained are in addition to and not by way of limitation of or substitution for any other guarantee or guarantees heretofore given to you by us whether jointly with others or alone and now existing uncancelled and that this guarantee is not intended to and shall not revoke or limit such guarantee or guarantees.



ISO 9001 Company

**Heavy Engineering Corporation Limited**  
(A Govt. of India Enterprise)  
**Heavy Machine Building Plant**  
**Ancillary & Contract Department**

---

11. This guarantee shall not be affected by any change in the constitution of the contractor or us nor shall it be affected by any change in your constitution or by any amalgamation or absorption thereof or therewith but will ensure for the benefit of and be available to and enforceable by the absorbing or amalgamated company or concern.
12. This guarantee is irrevocable during the period of its currency and shall not be revoked without your previous consent in writing.
13. We further agree and undertake to pay you the amount demanded by you in writing irrespective of any dispute or controversy between you and the contractor or any reference to arbitration of the said dispute / controversy pending or a civil suit filed by the contractor in respect of the dispute or controversy.
14. Notwithstanding anything contained herein above our liability under this guarantee is restricted to rs. ....'amount'.....(rupees ..... 'amount in words'.....) and this guarantee shall remain in force until ..... 'date'.... unless a written claim is lodged on us for payment under this guarantee within six months from the date of expiry of this guarantee i.e. on or before ...'date' + '6 month'..... all your rights under this guarantee shall be forfeited and we shall be deemed to have released and discharged from all liabilities thereunder. irrespective of whether or not the original guarantee is returned to us.
15. We have power to issue this guarantee in your favour under the memorandum and articles of association of the bank and the undersigned has full power to execute this guarantee under the power of attorney granted to them by the bank.

FOR AND ON BEHALF OF  
'name of bank'

'signature with seal'

1050.07.500

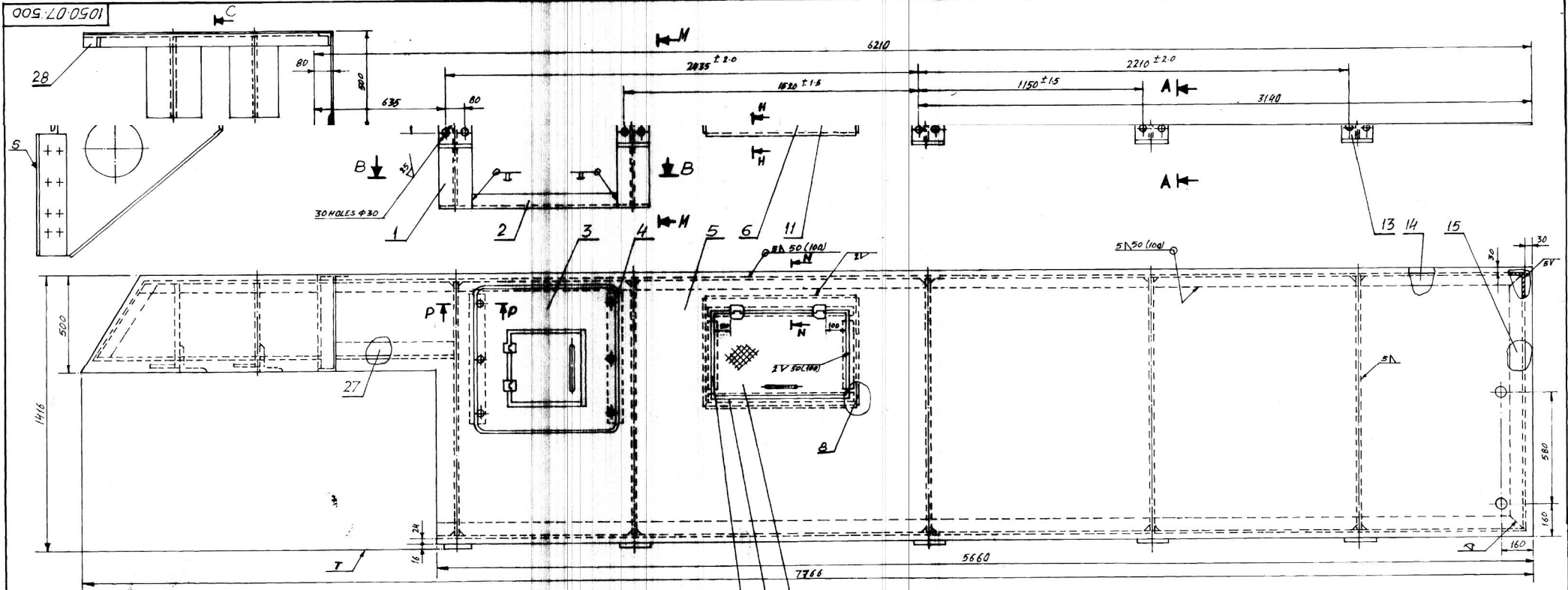

SECTION B-B

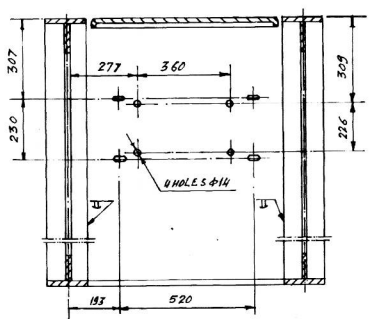

SECTION M-M

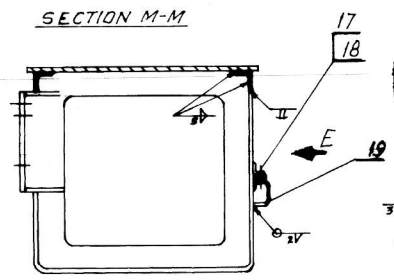

VIEW-E

SECTION A-A

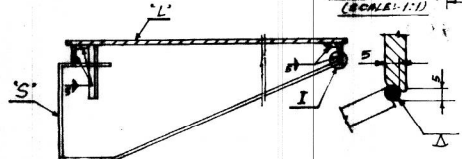

SECTION H-H

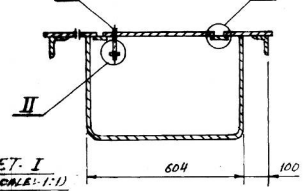

DET. I (SCALE: 1:1)

SECTION N-N (TURNED) (SCALE: 1:2)

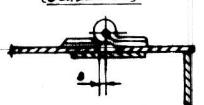

DET. II (SCALE: 1:1)

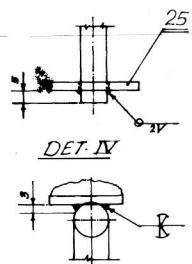

DET. IV

SECTION R-R (SCALE: 1:2)

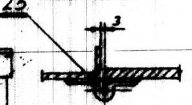

DET. III (SCALE: 1:1)

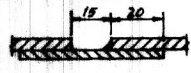

SECTION P-P (SCALE: 1:2)

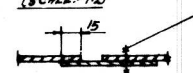

TECHNICAL INSTRUCTIONS

1. Manufacture and acceptance as per W.D. det.  
 2. Use electrodes as per IS-818-91 EN840 GROUP.

surface "L" is to be within 3mm.  
 u. Min thickness of surface "T" to be within 5mm.

18	1050-07-505	Top Frame Assy.	1	Assly	
17	1050-07-338	ISA 75 55x8, L=650	1	No drg.	
26	1050-07-337	ISA 75 75x8, L=420	1		
25	-	Machined Washer 13	8	014-03-2	
14	-	SL. C. S. Hd. screw M12 x 25	6	014-003-2	
23	-	Hinge (M) 75, Unranked	4	008-8334	
22	1040-07-336	Bent sheet	1		
21	1040-07-335	ISA 50 50x5, L=210	1		
20	1040-07-334	ISA 50 50x5, L=50	1		
19	1040-07-338	Handle	1		
18	-	Hex Nut M12	7	014-001-3	
17	-	Hex screw M12 x 40	1	014-003-9	
16	1040-07-311	Bent rod Ø12	1		
15	1050-07-333	ISA 75 75x8, L=1330	1		
14	1050-07-332	ISA 75 75x8, L=6150	1		
13	1050-07-328	Bracket Assy	3	Assly	
12	1050-07-339	ISSH 3.20x5x2	2	No drg.	
11	1040-07-327	Bent sheet	1		
10	1040-07-326	ISSH 740x55x2	2	No drg.	
9	1050-07-325	chgd. plate	1		
8	1040-07-324	ISSH 600x397x2	2	No drg.	
7	1050-07-321	ISA 50 50x5, L=250	14	No drg.	
6	1040-07-320	ISA 75 75x8, L=5620	1		
5	1050-07-391	Base plate Assy	1	Assly	
4	1040-07-316	Packing	2		
3	1040-07-310	Cover Assy	1	Assly	
2	1050-07-303	Plate	1		
1	1050-07-301	Bracket Assy	2	Assly	
ITEM NO.	DRG. NO.	DESCRIPTION	NO.	REMARKS	



SIDE PLATFORM  
L.H.

1050-07-500

WEIGHT IN KG: 947.0

SCALE: 1:10

Sept. 24

OTS-Lo.0501

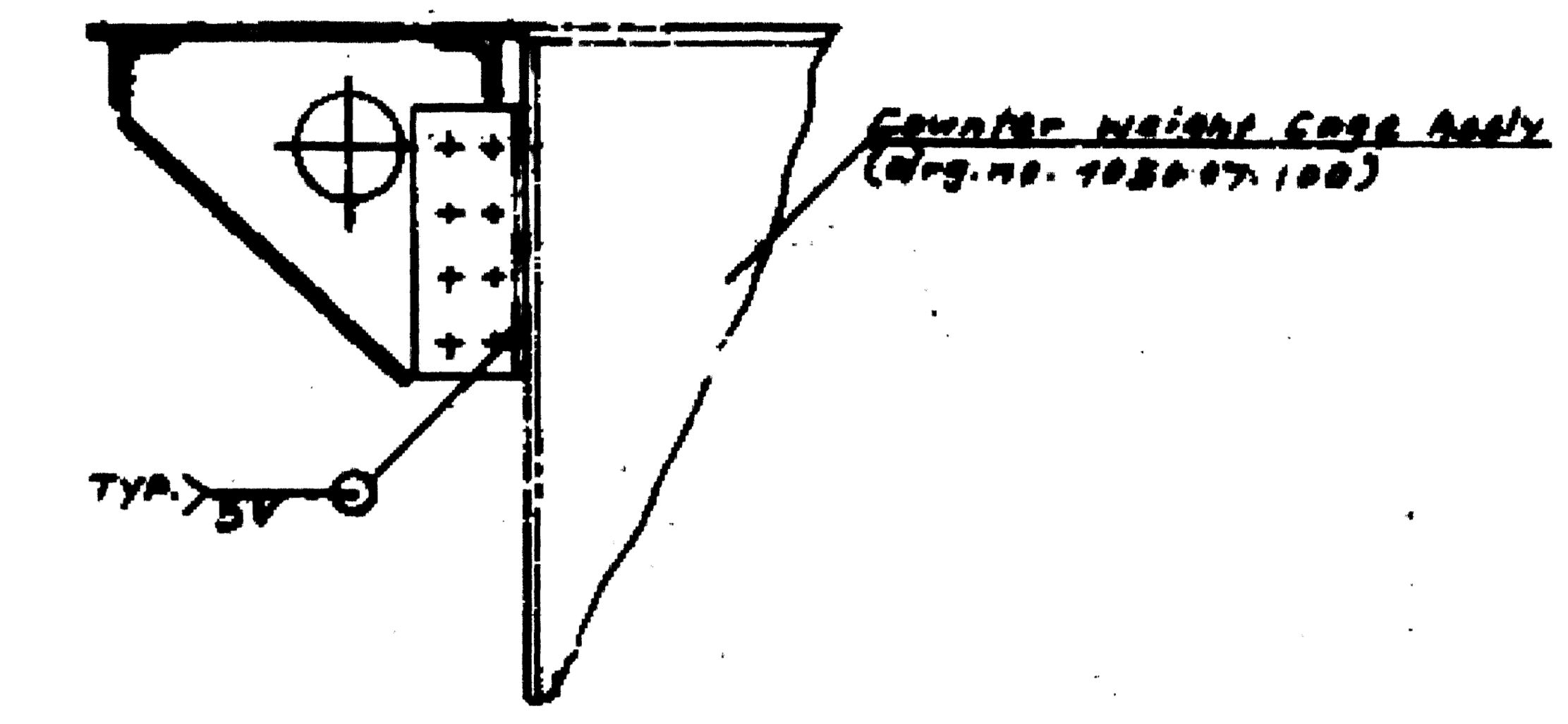


Weld Metal - 2kg				
Item No.	Org. No.	Description	Qty	Remarks
43		Machined Washer 10x5	8	016-013-2
42		Hex Nut M10	8	016-011-3
41		Hex Bolt M20x70	2	016-011-3
40		Hex Screw M10x25	20	016-011-3
39	1050-07-270	Plate 55x55x8	2	
38		Punched washer M12	8	016-011-2
37		Hex Nut M12	8	016-011-2
36	1050-07-165	Rib	1	
35	1050-07-268	Rib	1	
34	1050-07-267	ISA 90 60x6, L: 620	1	Ready
33	1050-07-266	Bent sheet	1	
32	1050-07-265	Sheet Assy	1	Ready
31	1050-07-264	ISA 75 75x8, L: 8762	1	
30	1050-07-263	ISA 50 50x6, L: 145	4	Ready
29	1050-07-262	Bent sheet	1	
28	1050-07-261	Bent sheet	6	
27	1050-07-260	Bent sheet	2	
26	1050-07-259	Bent sheet	3	
25	1050-07-258	ISA 120x60x2	1	
24	1050-07-257	Bent sheet Assy	1	Ready
23	1050-07-256	Bent sheet	1	
22	1050-07-255	ISA 75 75x8, L: 1647	1	
21	1050-07-254	ISA 75 75x8, L: 8347	1	
20	1050-07-253	Plate 870x100x8	1	Ready
19	1050-07-252	Square 20x20, L: 885	1	Ready
18	1050-07-251	ISA 90 60x6, L: 1222	2	Ready
17	1050-07-250	ISA 90 60x6, L: 1047	2	Ready
16	1050-07-249	ISA 50 50x6, L: 125	6	Ready
15	1050-07-248	Bracket	2	Ready
14	1050-07-247	Bracket	1	Ready
13	1050-07-246	Bracket	2	Ready
12	1050-07-245	ISA 90 60x6	1	
11	1050-07-244	TOP Platform RH	1	Ready
10	1050-07-243	ISA 90 60x6	1	
9	1050-07-242	Cover plate	1	
8	1050-07-241	Cover	1	Ready
7	1050-07-240	ISA 90 60x6	1	Ready
6	1050-07-239	ISA 87x100x4	1	Ready
5	1050-07-238	Plate 149x55x5	1	
4	1050-07-237	Plate 149x55x5	1	Ready
3	1050-07-236	Plate 201x55x5	2	
2	1050-07-235	Checkered plate	1	
1	1050-07-234	Checkered plate	1	

No.	Description	Quantity	Unit

110-1-1961

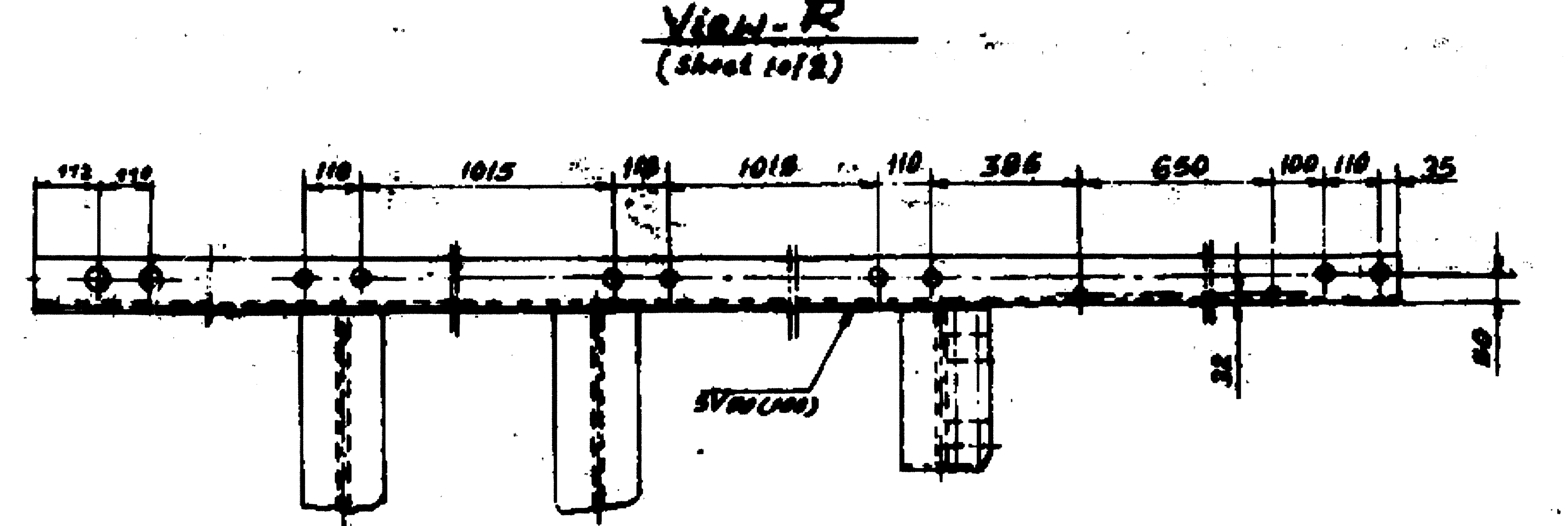
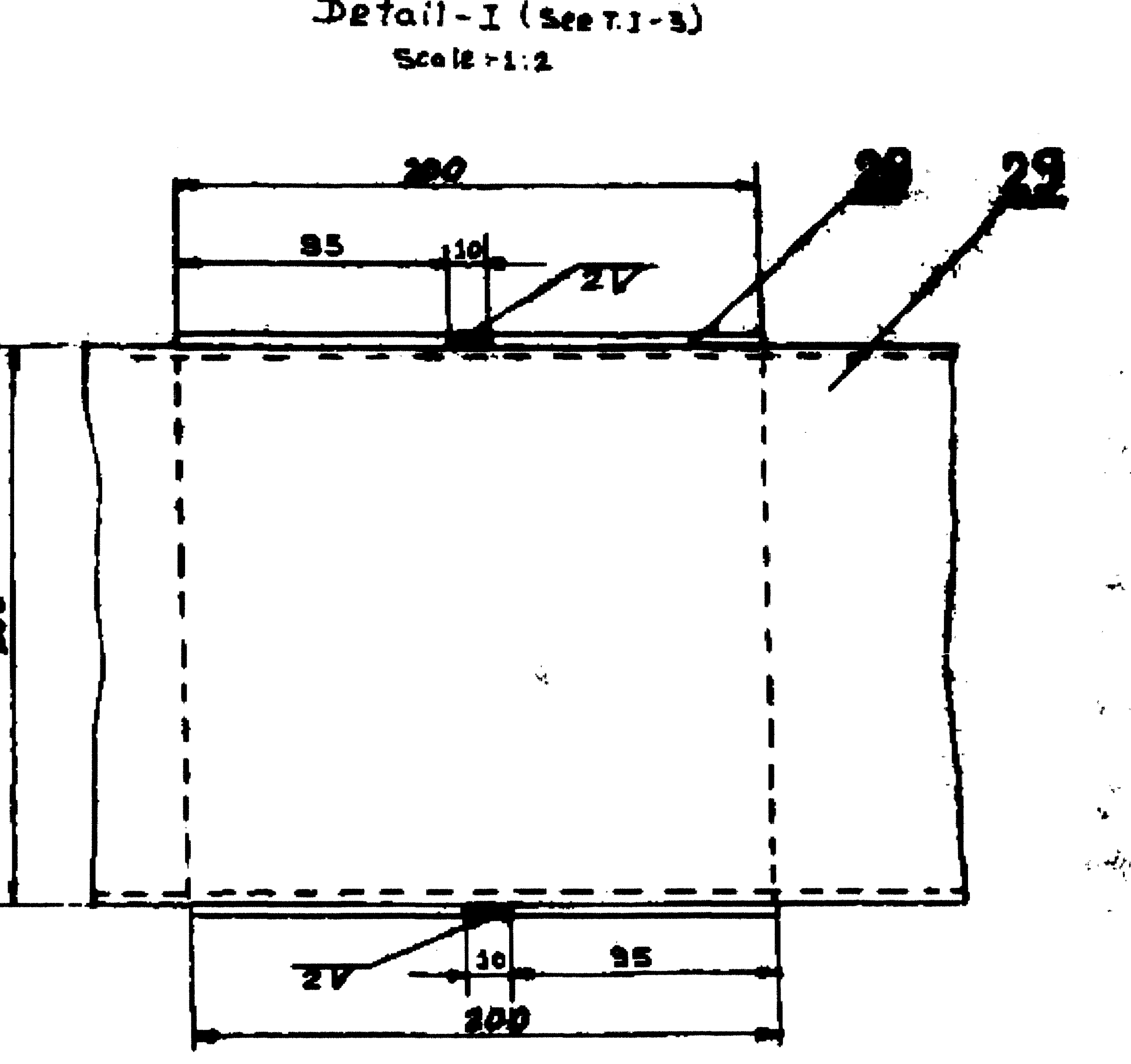
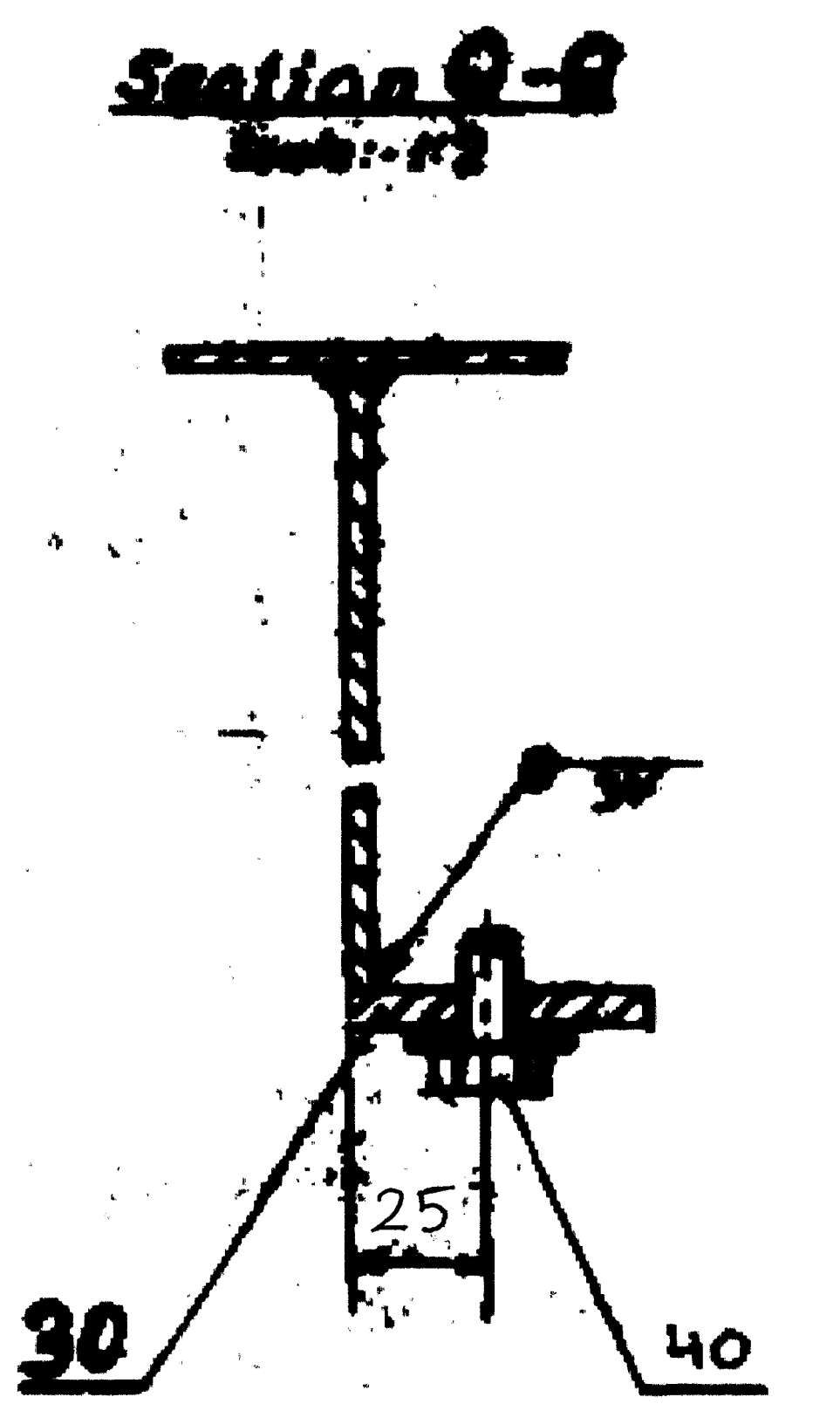
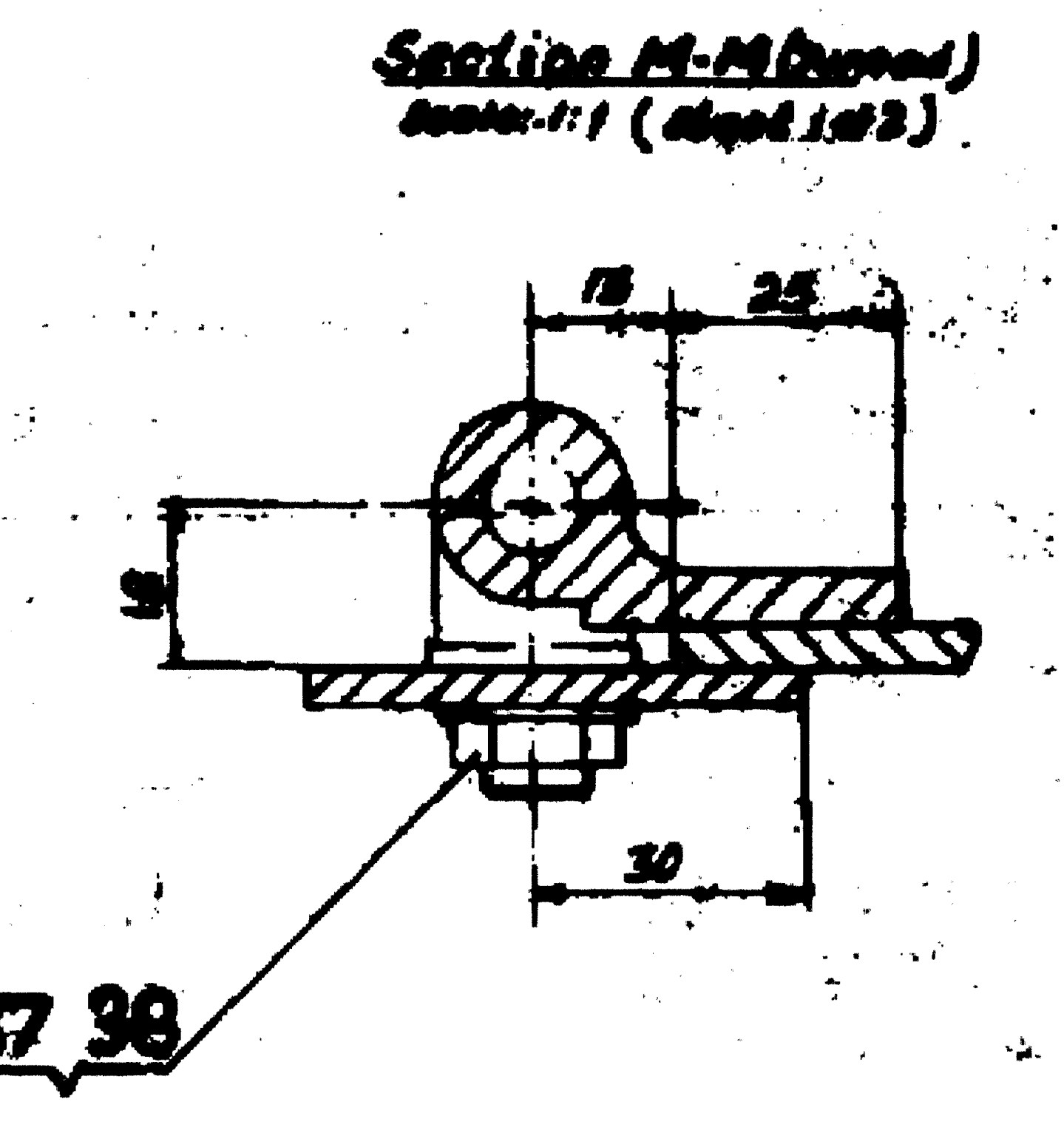
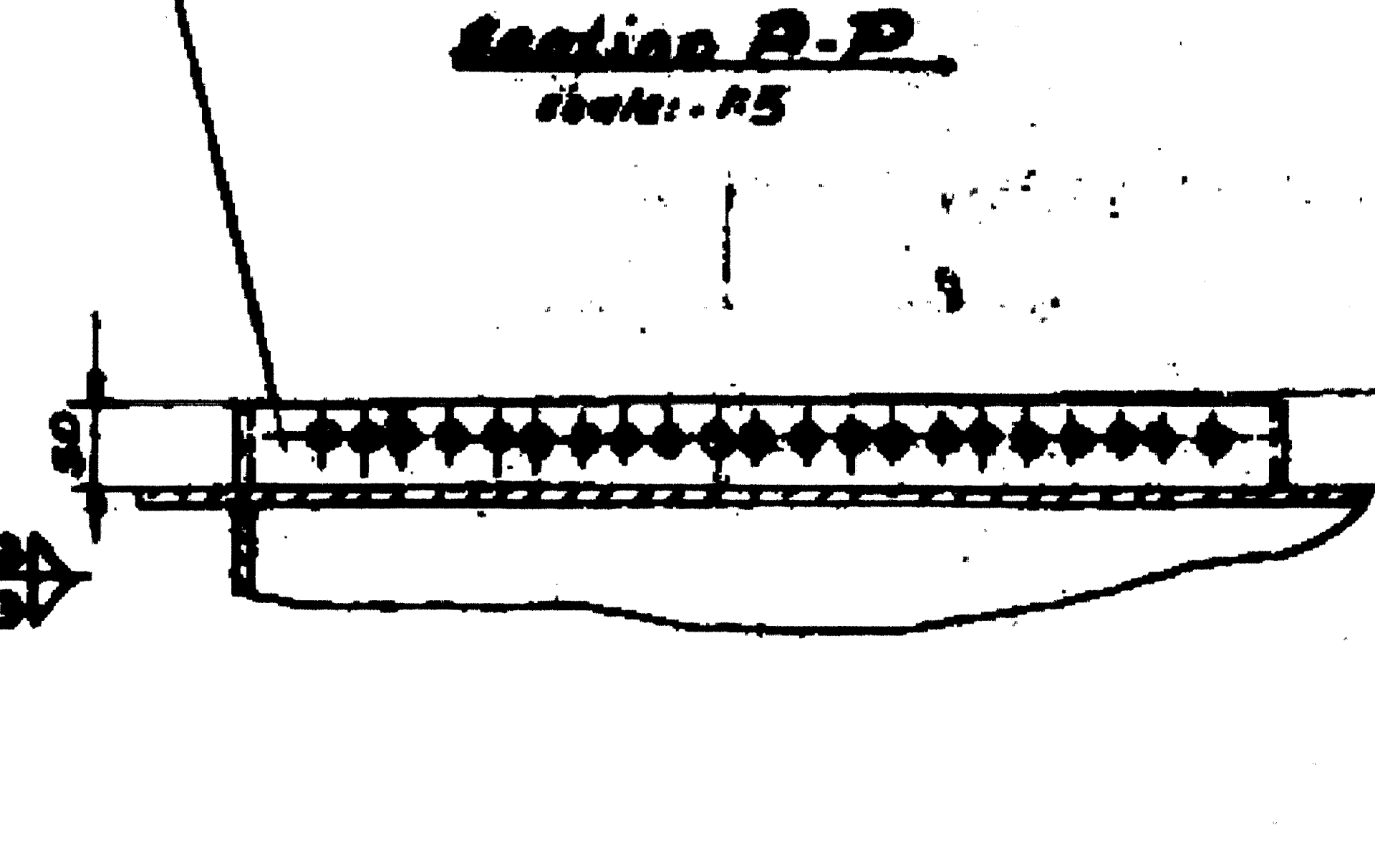
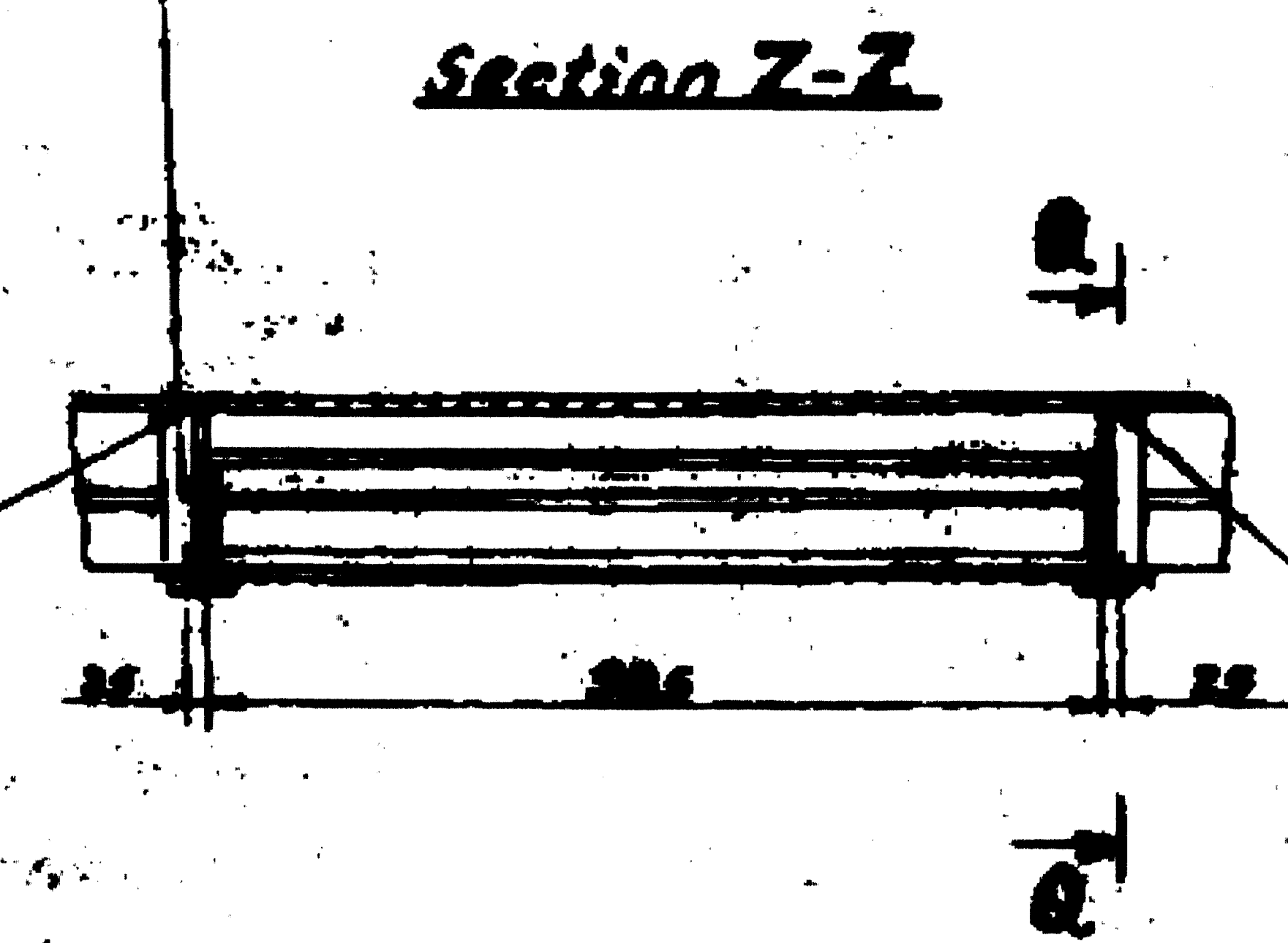
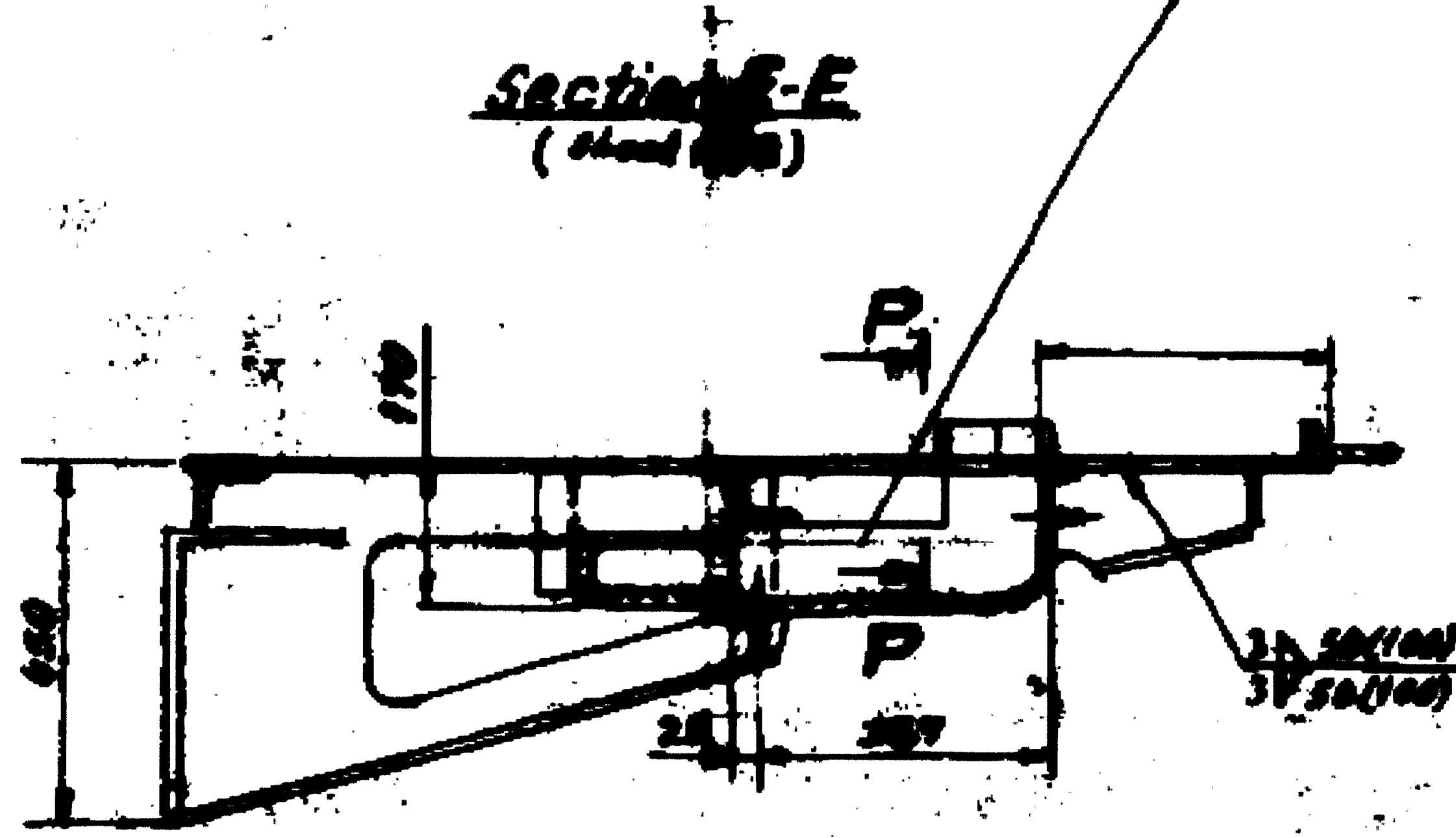
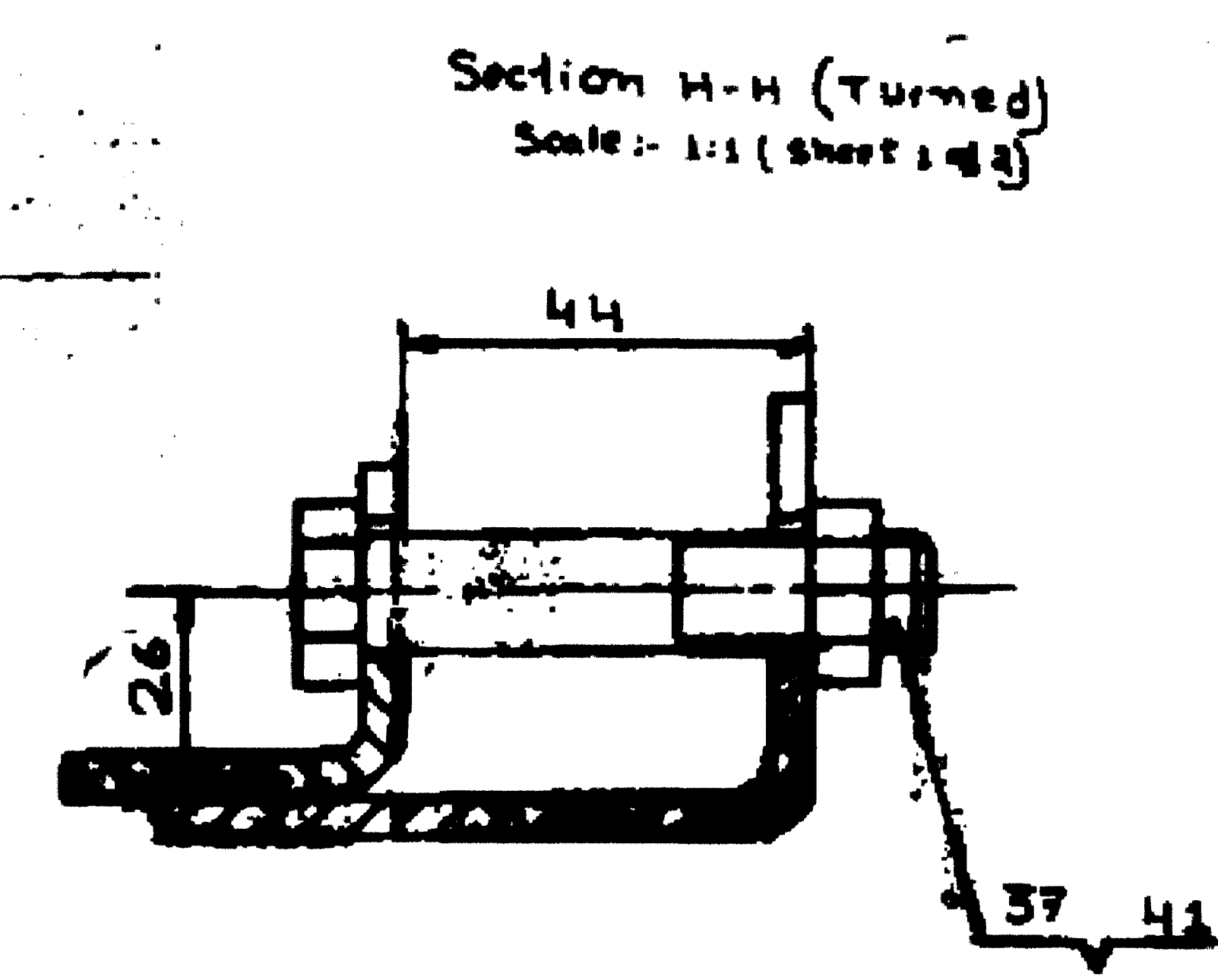


	Side Platform R.M.	(Sheet 2 of 2) 1050.07.510
	1050.07.200 1050.07.001 1050.07.002	1050.07.100 1050.07.101 1050.07.102
1050.07.300 1050.07.301 1050.07.302	1050.07.400 1050.07.401 1050.07.402	1050.07.500 1050.07.501 1050.07.502