



ISO 9001 Company

Heavy Engineering Corporation Limited
(A Govt. of India Enterprise)
Heavy Machine Building Plant
Ancillary & Contract Department

Open Tender Notice

Tender No. ACD/HMB/22/FA/2154/OTE-6301 dtd 16.02.2022 is available on our website in e-procurement section i.e. <https://etenders.gov.in/eprocure/app>. Aspiring bidders may go through the tender document.

Interested bidders are requested to submit their most competitive offer through e-procurement mode only. Offer submitted through offline mode will not be considered. For more information please visit our website <https://etenders.gov.in/eprocure/app>.

| | | |
|-----------------------------|------------|----------|
| Bid submission closing date | 07.03.2022 | 01:00 PM |
| Technical Bid opening date | 08.03.2022 | 03:00 PM |

Prospective Tenderers are advised to get register themselves only on at NIC e-tender portal i.e. <https://etenders.gov.in/eprocure/app>, obtain 'User ID' & 'Password' and go through the 'Self Help files' available in the Home Page after log in to the portal <http://etenders.gov.in>. They should also obtain Class III Digital Signature Certificate (DSC) in parallel which is essentially required for submission of their application. Detailed instructions for online bid submission are attached in **annexure-6**. No registration fee would be charged from the bidders.

Bidders are required to upload the bid along with all supporting documents including priced part (BoQ) only on the e-tendering website (<https://etenders.gov.in/eprocure/app>), on or before the due date and time for submission of bid.

NOTE:

- 1. Any Future changes/notifications including extension of bid due date, pertaining to this tender will be published/hosted only on website & CPP Portal only.**
- 2. This procurement of goods under the reference tender is covered under Public Procurement Policy 2017, revised 16.09.2020 and here in after any further revisions.**



ISO 9001 Company

Heavy Engineering Corporation Limited
(A Govt. of India Enterprise)
Heavy Machine Building Plant
Ancillary & Contract Department

Submission of tender

The Following 2 covers shall be submitted through online CPP - portal by the bidders. Last date and time of submission of bids (cover 1, 2) is as per given dates.

Cover – I: - Containing Techno-Commercial bid

Cover – I containing

- i. Duly Filled Annexure-1
- ii. Self Attested Ref. and PO as per Qualification criteria for the bidder.
- iii. Self Attested Manufacturing Facilities available at your works for the same work/similar work as per Qualification Criteria for the bidder.
- iv. All other documents as per Annexure 1 and Self Declaration as per Annexure 3

Cover - II: Price Bid (BoQ)

a) The tenderer shall upload the digitally signed Schedule of price bid in the form of BOQ.xls

Bidders may please note, the schedule of quantities is attached in the portal. The same (BOQ) shall be downloaded and be filled in the editable (un protected) cells only and they should necessarily submit their financial bids in the format provided after entering the financial quotes, name of the bidder etc.

Bid Opening Process is as below:-

Cover-I: Technical bid opening date will be as per given dates. If any clarification is needed from the bidder about the deficiency in his uploaded documents in Cover-I, he will be asked to provide it through Short fall documents folder in e-tendering portal one time only or through mail. The bidder shall upload the requisite clarification / documents within time specified by HEC, failing which tender will be liable for rejection.

Cover-II: The financial bids of the contractors / firms found to be meeting the qualifying requirements and technical criteria shall be intimated through portal. (Depending on Cover-I evaluation any changes in the date shall be intimated through e-tendering portal).



ISO 9001 Company

Heavy Engineering Corporation Limited
(A Govt. of India Enterprise)
Heavy Machine Building Plant
Ancillary & Contract Department

OPEN TENDER

No. ACD/HMB/22/FA/2154/OTE-6301

Date: 16/02/2022

(A) Scope of Supply:

HEC intends to procure the "Platform (LH) & Side Platform (RH)". Interested firms are requested to submit their most competitive offer for supply of following item as per the technical Instructions and the terms & conditions given below.

| Sl. No. | Drg.No. | Desc. | Set | Wt per set (Kg) | Material Grade |
|---------|-------------|--------------------|-----|-----------------|----------------|
| 1 | 1050.07.530 | Platform (LH) | 02 | 1087.00 | As per Drgs |
| 2 | 1050.07.510 | Side Platform (RH) | 02 | 1191.00 | As per Drgs |

(B) Technical Instructions:

1. Items are to be supplied as per HEC drawings and its technical instructions.
2. Items should be of good surface finish as per HEC drawing and free from any defect.

Note - Drawings are enclosed with the NIT & detailed drawings are available in our office (ACD)/HMBP, HEC Ltd. for study on any working day before opening of tender.

(C) Qualification Criteria for the bidders

1. Self Attested Reference & Photocopies of executed PO's placed on you by HEC /Other companies for same/similar Work.
2. Self Attested copies of Manufacturing Facilities available at your works for the same work/ similar work.

Terms & Conditions

1. The rate quoted shall be Inclusive of all packing & forwarding, Freight charges & insurance on F.O.R HMBP Stores.
2. The Price quoted by the tenderer should be exclusive of GST. The rate and nature of GST applicable should be shown separately. GST will be paid to the seller at the rate at which it is liable to be assessed or has actually been assessed on the date of supply provided the transaction of sale is legally liable to GST and within the delivery period.
3. **Validity of offer** - The rates quoted must be firm and the offer made must remain valid for acceptance up to **three months** from the date of opening of the tender. The rate quoted must be in word and figure as well. In case any discrepancy in rate given in figures and word, the rate given in words will prevail.
4. **Payment terms:** 90% payment along with 100% taxes and duties within two months of receipt of material in HMBP and 10% against C.R.V (to be issue by our Stores after receipt and acceptance of material at HMBP). In case of any deviation by the bidders necessary loading @ 1% Per Month (12% max Per Year) on quoted price shall be applicable and L-1 firm will be decided based on landed cost after loading on quoted price.
5. **Delivery Schedule –**
 - A. 1st set **within 45 days from the date of issue of PO.**
 - B. 2nd set **within two month from the date of issue of PO.**



ISO 9001 Company

Heavy Engineering Corporation Limited
(A Govt. of India Enterprise)
Heavy Machine Building Plant
Ancillary & Contract Department

6. Full particular i.e. specification, literature and or drawing wherever applicable should be submitted along with the quotation.
7. The Corporation does not pledge itself to accept the lowest or any tender and reserve to itself the right of accepting the whole or any part of tender or portion of the quantity offered and you shall supply the same at the rate quoted.
8. Inspection of the manufactured items will be done by QCA/HMBP or his authorized representative at supplier's works, Necessary tools and measuring instruments to be provided by the supplier.
9. Corporation reserves the right to call for and examine at any time the books of accounts and other document and papers of the firm for the purpose of ascertaining whether any excess payment has been made or the firm likely to be received / received undue benefit out of execution of the particular contract.
10. **Earnest Money Deposit –Rs 5,000/-** will have to be deposited by demand draft on any of the nationalized banks in favor of "Heavy Engineering Corporation Limited, payable at Ranchi" or in the form of Bank Guarantee as per annexure. The copy of EMD in form of DD/BG will have to enclose in the Techno- Commercial bid (Part 1) and the original copy of the same has to reach before opening date of tender. Exemption of EMD shall be applicable on submission of valid SSI/NSIC/MSME certificate and as per prevailing govt guidelines. SSI/NSIC/MSME Certificate to be enclosed in Techno Commercial Bid Part 1.
11. **Tender Fee (Non Refundable) –Rs 200/-** will have to be deposited by demand draft on any of the nationalized banks in favor of "Heavy Engineering Corporation Limited, payable at Ranchi. The copy of Tender Fee in form of DD will have to enclose in the Techno- Commercial bid (Part 1) and the original copy of the same has to reach before opening date of tender. Exemption of Tender Fee shall be applicable on submission of valid SSI/NSIC/MSME certificate and as per Govt rules. SSI/NSIC/MSME Certificate to be enclosed in Techno Commercial Bid Part 1.
12. **Security deposit (SD)** – Successful tenderers will have to deposit security equal to 5 % of the value of the contract within the desired period i.e. within 21 days of PO date. Failing this, the contract will be cancelled at the risk and expenses of the suppliers. SD will have to be deposited by demand draft on any of the nationalized banks in favor of "Heavy Engineering Corporation Limited, payable at Ranchi" or in the form of Bank Guarantee as per Annexure.
13. **Delivery :** The time for and the date of delivery of the Stores stipulated in the acceptance of tender shall be deemed to be the essence of the Contract and delivery must be completed not later that the dates specified therein. Otherwise:
 - a. The purchaser to recover from the Contractor a sum of 0.5% per week (Completed week) of the price of the Stores (upto maximum 10%) as liquidated damages, which the contractor has failed to deliver as a foresaid or
 - b. The purchaser may procure the undelivered stores/ similar items from elsewhere, without notice to the contractor at the risk of the contractor without canceling the contract in respect of the consignment not yet due for delivery or
 - c. To cancel the contract or a portion thereof.
14. There is no obligation on our part to accept delayed / late tenders. Tenders received after the due date of opening are liable to be summarily rejected.
15. The rates quoted shall also be inclusive of embossing on the material. The ownership namely HMBP should be at a predominant place of the material to a size/ thickness upon the volume of the material.



ISO 9001 Company

Heavy Engineering Corporation Limited
(A Govt. of India Enterprise)
Heavy Machine Building Plant
Ancillary & Contract Department

16. The corporation reserves the right to reject any / all tender partly / fully and no tenderer can ask any explanation anywhere in this regard.
17. Successful Bidders have to sign the confidentially agreement in HEC's format.
18. Guarantee clause- The items supplied shall be guaranteed for a period of 12 months from the date of commissioning or 18 months from the date of delivery whichever is earlier against defective materials or bad workmanship
19. The repeat order for 100% quantity may be placed on successful bidder/bidders within one year from the date of delivery of the original Purchase Order on mutual agreement.
20. Order placed as a result of this tender will be governed by the Corporation's General Terms and Conditions of Contract which can be referred in HEC's website www.hecltd.com

Note:-

1. As per the govt. Guidelines it is to be specified clearly in your offer whether your firm is registered with SSI/NSIC/MSME and also confirm whether the firm is owned by SC/ST Entrepreneurs or not.
2. Pl. provide UAM no to avail Facilities of MSME.
3. Please get registered your firm with HEC Ltd.

FOR AND ON BEHALF OF HEC Ltd.



ISO 9001 Company

Heavy Engineering Corporation Limited
(A Govt. of India Enterprise)
Heavy Machine Building Plant
Ancillary & Contract Department

Annexure – 1

PART – I (Techno – Commercial Bid)

No. ACD/HMB/22/FA/2154/OTE-6301

Date: 16/02/2022

| Sl.No. | Requisite | (✓) | | Remark |
|--------|--|-----|----|--|
| 1 | Whether the scope of Supply (A) & technical instruction (B) mentioned in the tender enquiry is acceptable. | Yes | No | |
| 2 | Self Attested Reference & Photocopies of executed PO's placed on you by HEC /Other companies for same/similar work as per qualification criteria(C). | Yes | No | (Upload the relevant documents) |
| 3 | Self Attested copies of Manufacturing Facilities available at your works for the same work/similar work as per qualification criteria(C). | Yes | No | (Upload the relevant documents) |
| 4 | Whether SSI/NSIC/MSME (For exemption of Tender Fee and EMD only), Also mention UAN No..... | Yes | No | (Upload the relevant documents) |
| 5 | Whether EMD & Tender Fee deposited (As per clause 10 & 11 of Terms & conditions) | Yes | No | (Upload the copy of DD/ BG) |
| 6 | F.O.R. HMBP (As per clause 1 of Terms & condition) | Yes | No | |
| 7 | Payment Term (As per clause 4 of Terms & condition) | Yes | No | (In case your answer is No, then please mention your term) |
| 8 | Delivery Term(As per clause 5 of Terms & condition) | Yes | No | (In case your answer is No, then please mention your term) |
| 9 | Validity (As per clause 3 of Terms & conditions) | Yes | No | |
| 10 | L.D. Clause(As per clause 13(a) of Terms & conditions) | Yes | No | |
| 11 | Risk Purchase Clause (As per clause 13(b) of Terms & conditions) | Yes | No | |
| 12 | Guarantee Clause (As per clause 18 of Terms & conditions) | Yes | No | |
| 13 | Security Deposit (As per clause 12 of Terms & conditions) | Yes | No | |
| 14 | GST Registered | Yes | No | GST rate..... |
| 15 | Inspection Clause (As per clause 8 of Terms & conditions) | Yes | No | |
| 16 | GeM seller unique ID on www.gem.gov.in | Yes | No | (If yes, pl provide the same) |
| 17 | Firm is owned by SC/ST Entrepreneurs | Yes | No | |
| 18 | Whether Terms & Condition/Note etc. mentioned in the tender enquiry is acceptable to the tenderer | Yes | No | |
| 19 | Contact person Name: Email: Contact number: | Yes | No | |

Note : In case of non-submission / submission of incomplete documents, your offer may not be considered for the said Enquiry.

(Signature of Tenderer)
With official Seal



ISO 9001 Company

Heavy Engineering Corporation Limited
(A Govt. of India Enterprise)
Heavy Machine Building Plant
Ancillary & Contract Department

Annexure – 2

PART-II (Price Bid)

The tenderer shall upload the digitally signed Schedule of price bid in the form of BOQ.xls

Bidders may please note, the schedule of quantities is attached in the portal. The same (BOQ) shall be downloaded and be filled in the editable (unprotected) cells only and they should necessarily submit their financial bids in the format provided after entering the financial quotes, name of the bidder etc.



ISO 9001 Company

Heavy Engineering Corporation Limited
(A Govt. of India Enterprise)
Heavy Machine Building Plant
Ancillary & Contract Department

Annexure – 3

No. ACD/HMB/22/FA/2154/OTE-6301

Date: 16/02/2022

Self-Declaration

I _____, Son / Daughter of
Shri _____ age _____ years, resident of
_____ in the District of _____, do hereby
declare that all the information given in the offer and in the enclosed documents is true
to the best of my knowledge and belief and nothing has been concealed therein. I am
well aware of the fact that if the information given by me is proved false / not true at any
point of time, I will have to face punishment as per any provision of Law for the time
being in force as well as the benefit availed of by me or the benefit accrued to me shall
be summarily cancelled.

Date: -

(Signature of Tenderer)
With official Seal



ISO 9001 Company

Heavy Engineering Corporation Limited
(A Govt. of India Enterprise)
Heavy Machine Building Plant
Ancillary & Contract Department

Annexure 4

Format for

BANK GUARANTEE FOR EARNEST MONEY DEPOSIT

(to be issued by any Nationalized bank preferably State bank of India negotiable at their counters in Ranchi)

NO.

Dated:

TO
M/S HEAVY ENGINEERING CORPORATION LIMITED
PLANT PLAZA ROAD,
DHURWA,
RANCHI – 4

Dear Sirs,

In consideration of your agreeing to accept the Earnest money deposit of Rs.-----
(Rs-----) furnishable to you by M/s-----
------(Hereinafter
Referred to As Contractor) In terms of the Enquiry No. -----
-----Dtd. ----- for Supply of -----
(Hereinafter Referred to as the Contract) in the form of a Bank Guarantee in the Manner
hereinafter contained we -----, having
registered office at -----do hereby covenant and
agree with you as follows.

1. We hereby undertake to indemnify you up to a sum of Rs. ----- (Rs. -----
----- only) against any loss or damage caused to or suffered by you
or that may be caused to or suffered by you by reason of any breach or breaches on the
part of the contractor of any of the terms and conditions contained in the said contract
and in the event the Contractor shall make any default or defaults in carrying out any of
the works under the said contract or otherwise in the observance and performance of
any of the terms and conditions relating thereto in accordance with the true intent and
meaning thereof, we shall forthwith on demand and without any protest or demur pay to
you such sum or sums not exceeding in total the said sum of Rs.----- (Rs. -----
-----amount-----only) as may be claimed by you as your losses and/or
damages, costs, charges or expenses by reason of such default or defaults on the part of
the contractor.



ISO 9001 Company

Heavy Engineering Corporation Limited
(A Govt. of India Enterprise)
Heavy Machine Building Plant
Ancillary & Contract Department

2. Notwithstanding anything to the contrary contained in this guarantee your decision as to whether the contractor has made any such default or defaults and the amount or amounts to which you are entitled by reasons thereof will be binding on us and we shall not be entitled to ask you to establish your claim or claims or damages or losses suffered by you but will pay the amount demanded by you under this guarantee forthwith on your demand without any protest or demur.

3. This guarantee shall continue and hold good until it is released by you on the application by the contractor after expiry of the related warranty period of the said contract and after the contractor have discharged all their obligations under the said contract and produced a certificate of due completion of the work under the said contract and submitted a "NO Demand Certificate" provided always that this guarantee shall in no event remain in force after the date of----- without prejudice to your claim or claims arisen and demanded from or otherwise notified to us in writing before the expiry of six months from the said date which will be enforceable against us not withstanding that the same is or are enforced after the said date.

4. We-----, further undertake to extend the validity of this beyond the period prescribed in clause 3 or as extended from time to time for such further period as may be required in writing before the Expiry of this and upon such extension(s), all terms and conditions of this shall remain in full force till the expiry of this extended period(s).

5. You will have the fullest liberty without affecting this guarantee from time to time to vary any of the terms and conditions of the said contract or extend the time of performance of the contractor or to postpone for any time or from time to time any of your rights or powers against the contractor and either to enforce or forbear to enforce any of the terms and conditions of the said contract and we shall not be released from our liability under this guarantee by the exercise of your liberty with reference to matters aforesaid or by reason of any time being given to the contractor or any other forbearance, act or omission on your part or any indulgence by you to the contractor or by any other variation or modification of the said contract or any other act, matter or things whatsoever, which, under the law relating to sureties, would but for the provisions hereof, have the effect of so releasing us from our liability hereunder provided always that nothing herein contained will enlarge our liability hereunder beyond the limit of Rs. - -----(Rs.-----) as aforesaid or extend the period of the guarantee beyond the said Date of -----unless expressly agreed to by us in writing in terms of clause 4 hereof.

6. This guarantee shall not in any way be affected by your taking or varying or giving up any securities from the contractor or any other person, firm or company on its behalf or by the winding up, dissolution, insolvency or death as the case may be of the contractor.

7. In order to give full effect to the guarantee herein contained, you shall be entitled to act as if we are your principal debtors in respect of all your claims against the contractor hereby guaranteed by us as aforesaid and we hereby expressly waive all our rights of



ISO 9001 Company

Heavy Engineering Corporation Limited
(A Govt. of India Enterprise)
Heavy Machine Building Plant
Ancillary & Contract Department

suretyship and other rights, if any, which are in any ways inconsistent with any of the provisions of this guarantee.

8. Subject to the maximum limit of our liability as aforesaid this guarantee will cover all your claim or claims against the contractor from time to time arising out of or in relation to the said contract and in respect of which your claim in writing is lodged on us before expiry of six months from the date of expiry of this guarantee.

9. Any notice by way of demand or otherwise hereunder shall be in writing and may be sent by special Courier or Telefax to us or our Local Address as aforesaid.

10. This guarantee and the powers & provisions herein contained are in addition to and not by way of limitation or substitution for any other guarantee or guarantees heretofore given to you by us whether jointly with others or alone and now existing uncanceled and that this guarantee is not intended to and shall not revoke or limit such guarantee or guarantees.

11. This guarantee shall not be affected by any change in the constitution of the contractor or us nor shall it be affected by any change in your constitution or by any Amalgamation or absorption thereof or therewith but will ensure for the benefit or and be available to and enforceable by the absorbing or amalgamated company or concern.

12. This guarantee is irrevocable during the period of its currency and shall not be revoked without your previous consent in writing.

13. We further agree and undertake to pay you the amount demanded by you in writing irrespective of any dispute or controversy between you and the contractor or any reference to arbitration of the said dispute/controversy pending or a civil suit filed by the contract or in respect of the dispute or controversy.

14. Notwithstanding anything contained herein above our liability under this guarantee is restricted to Rs.----- (Rs. -----only) and this guarantee shall remain in force until -----unless a written claim is lodged on us for payment under this guarantee within six months from the date of expiry of this guarantee . i.e. On or before-----all your rights under this guarantee shall be forfeited and we shall be deemed to have released and discharged from all liabilities there under, irrespective of whether or not the original guarantee is returned to us.

15. We have power to issue this guarantee in your favour under the memorandum and articles of association of the bank and the undersigned has full power to execute this guarantee under the power of Attorney Granted to them by the Bank.

FOR AND ON BEHALF OF



ISO 9001 Company

Heavy Engineering Corporation Limited
(A Govt. of India Enterprise)
Heavy Machine Building Plant
Ancillary & Contract Department

Annexure 5

**Format for
BANK GUARANTEE FOR SECURITY DEPOSIT**

(to be issued by any Nationalized bank preferably State bank of India negotiable at their counters in Ranchi)

TO,

M/S HEAVY ENGINEERING CORPORATION LIMITED
PLANT PLAZA ROAD,
DHURWA,
RANCHI – 4

Dear sir,

In consideration of your agreeing to accept the security deposit of rs.'amount'..... furnishable to you by m/s 'firms name'..... (hereinafter referred to as contractor) in terms of the contract no.'hec's purchase order no'.....for supply of 'details of items'.....(hereinafter referred to as the 'contract') in the form of a bank guarantee in the manner hereinafter contained we....'bank details'..... branch, having registered office at 'place'..... do hereby covenant and agree with you as follows:

1. We hereby undertake to indemnify you up to a sum of rs.'amount'.....(rupees 'amount in words'.....) against any loss or damage caused to or suffered by you or that may caused to or suffered by you by reason of any breach or breaches on the part of the contractor of any of the terms and conditions contained in the said contract and in the event the contractor shall make any default or defaults in carrying out any of the works under the said contract or otherwise in the observance and performance of any of the terms and conditions relating thereto in accordance with the true intent and meaning thereof, we shall forthwith on demand and without any protest or demur pay to



ISO 9001 Company

Heavy Engineering Corporation Limited
(A Govt. of India Enterprise)
Heavy Machine Building Plant
Ancillary & Contract Department

you such sum or sums not exceeding in total the said sum of rs.'amount'.....(rupees 'amount in words'.....) as may be claimed by you as your losses and / or damages, costs, charges or expenses by reason of such default or defaults on the part of the contractor.

2. Notwithstanding anything to the contrary contained in this guarantee your decision as to whether the contractor has made any such default or defaults and the amount or amounts to which you are entitled by reasons thereof will be binding on us and we shall not be entitled to ask you to establish your claim or claims or damages or losses suffered by you but will pay the amount demanded by you under this guarantee forthwith on your demand without any protest or demur.
3. This guarantee shall continue and hold good until it is released by you on the application by the contractor after expiry of the related warranty period of the said contract and after the contractor have discharged all their obligations under the said contract and produced a certificate of due completion of the work under the said contract and submitted a 'no demand certificate' provided always that this guarantee shall in no event remain in force after the date of ...'date'..... without prejudice to your claim or claims arisen and demanded from or otherwise notified to us in writing before the expiry of six months from the said date which will be enforceable against us notwithstanding that the same is or are enforced after the said date.
4. We 'bank name'....., further undertake to extend the validity of this beyond the period prescribed in clause 3 or as extended from time to time, for such further period as may be required in writing before the expiry of this and upon such extension(s), all terms and conditions of this shall remain in full force till the expiry of this extended period(s).
5. You will have the fullest liberty without affecting this guarantee from time to time to vary any of the terms and conditions of the said contract or extend the time of performance of the contractor or to postpone for any time or from time to time any of your rights or powers against the contractor and either to enforce or forebear to enforce any of the terms and conditions of the said contract and we shall not be released from our



ISO 9001 Company

Heavy Engineering Corporation Limited
(A Govt. of India Enterprise)
Heavy Machine Building Plant
Ancillary & Contract Department

liability under this guarantee by the exercise of your liberty with reference to matters aforesaid or by reason of any time being given to the contractor or any other forbearance, act or omission on your part or any indulgence by you to the contractor or by any other variation or modification of the said contract or any other act, matter or things whatsoever, which, under the law relating to sureties, would but for the provisions hereof, have the effect or so releasing us from our liability hereunder provided always that nothing herein contained will enlarge our liability hereunder beyond the limit of rs.'amount'.....(rupees 'amount in words'.....) as aforesaid or extend the period of the guarantee beyond the said date of ...'date'.... unless expressly agreed to by us in writing in terms of clause 4 hereof.

6. This guarantee shall not in any way be affected by your taking or varying or giving up any securities from the contractor or any other person, firm or company on its behalf or by the winding up, dissolution, insolvency or death as the case may be of the contractor.
7. In order to give full effect to the guarantee herein contained, you shall be entitled to act as if we are your principal debtors in respect of all your claims against the contractor hereby guaranteed by us as aforesaid and we hereby expressly waive all our rights of suretyship and other rights, if any, which are in any way inconsistent with any of the provisions of this guarantee.
8. Subject to the maximum limit of our liability as aforesaid this guarantee will cover all your claim or claims against the contractor from time to time arising out of or in relation to the said contract and in respect of which your claim in writing is lodged on us before expiry of six months from the date of expiry of this guarantee.
9. Any notice by way of demand or otherwise hereunder shall be in writing and may be sent by special courier, speed post or telefax to us at our local address as aforesaid.
10. This guarantee and the powers & provisions herein contained are in addition to and not by way of limitation of or substitution for any other guarantee or guarantees heretofore given to you by us whether jointly



ISO 9001 Company

Heavy Engineering Corporation Limited
(A Govt. of India Enterprise)
Heavy Machine Building Plant
Ancillary & Contract Department

with others or alone and now existing uncanceled and that this guarantee is not intended to and shall not revoke or limit such guarantee or guarantees.

11. This guarantee shall not be affected by any change in the constitution of the contractor or us nor shall it be affected by any change in your constitution or by any amalgamation or absorption thereof or therewith but will ensure for the benefit of and be available to and enforceable by the absorbing or amalgamated company or concern.
12. This guarantee is irrevocable during the period of its currency and shall not be revoked without your previous consent in writing.
13. We further agree and undertake to pay you the amount demanded by you in writing irrespective of any dispute or controversy between you and the contractor or any reference to arbitration of the said dispute / controversy pending or a civil suit filed by the contractor in respect of the dispute or controversy.
14. Notwithstanding anything contained herein above our liability under this guarantee is restricted to rs.'amount'.....(rupees 'amount in words'.....) and this guarantee shall remain in force until 'date'.... unless a written claim is lodged on us for payment under this guarantee within six months from the date of expiry of this guarantee i.e. on or before ...'date' + '6 month'..... all your rights under this guarantee shall be forfeited and we shall be deemed to have released and discharged from all liabilities thereunder. irrespective of whether or not the original guarantee is returned to us.
15. We have power to issue this guarantee in your favour under the memorandum and articles of association of the bank and the undersigned has full power to execute this guarantee under the power of attorney granted to them by the bank.

FOR AND ON BEHALF OF
'name of bank'

'signature with seal'



ISO 9001 Company

Heavy Engineering Corporation Limited
(A Govt. of India Enterprise)
Heavy Machine Building Plant
Ancillary & Contract Department

Annexure-6
Instructions for Online Bid Submission

The bidders are required to submit soft copies of their bids electronically on the CPP Portal, using valid Digital Signature Certificates. The instructions given below are meant to assist the bidders in registering on the CPP Portal, prepare their bids in accordance with the requirements and submitting their bids online on the CPP Portal.

More information useful for submitting online bids on the CPP Portal may be obtained at: <https://eprocure.gov.in/eprocure/app>.

REGISTRATION

- (i) Bidders are required to enroll on the e-Procurement module of the Central Public Procurement Portal (URL: <https://etenders.gov.in/eprocure/app>) by clicking on the link "Online bidder Enrollment" on the CPP Portal which is free of charge.
- (ii) As part of the enrolment process, the bidders will be required to choose a unique username and assign a password for their accounts.
- (iii) Bidders are advised to register their valid email address and mobile numbers as part of the registration process. These would be used for any communication from the CPP Portal.
- (iv) Upon enrolment, the bidders will be required to register their valid Digital Signature Certificate (Class II or Class III Certificates with signing key usage) issued by any Certifying Authority recognized by CCA India (e.g. Sify / nCode / eMudhra etc.), with their profile.
- (v) Only one valid DSC should be registered by a bidder. Please note that the bidders are responsible to ensure that they do not lend their DSC's to others which may lead to misuse.
- (vi) Bidder then logs in to the site through the secured log-in by entering their user ID / password and the password of the DSC / e-Token.

SEARCHING FOR TENDER DOCUMENTS

- i) There are various search options built in the CPP Portal, to facilitate bidders to search active tenders by several parameters. These parameters could include Tender ID, Organization Name, Location, Date, Value, etc. There is also an option of advanced search for tenders, wherein the bidders may combine a number of search parameters such as Organization Name, Form of Contract, Location, Date, Other



ISO 9001 Company

Heavy Engineering Corporation Limited
(A Govt. of India Enterprise)
Heavy Machine Building Plant
Ancillary & Contract Department

keywords etc. to search for a tender published on the CPP Portal.

- ii) Once the bidders have selected the tenders they are interested in, they may download the required documents / tender schedules. These tenders can be moved to the respective 'My Tenders' folder. This would enable the CPP Portal to intimate the bidders through SMS / e-mail in case there is any corrigendum issued to the tender document.
- iii) The bidder should make a note of the unique Tender ID assigned to each tender, in case they want to obtain any clarification / help from the Helpdesk.

PREPARATION OF BIDS

- i) Bidder should take into account any corrigendum published on the tender document before submitting their bids.
- ii) Please go through the tender advertisement and the tender document carefully to understand the documents required to be submitted as part of the bid. Please note the number of covers in which the bid documents have to be submitted, the number of documents - including the names and content of each of the document that need to be submitted. Any deviations from these may lead to rejection of the bid.
- iii) Bidder, in advance, should get ready the bid documents to be submitted as indicated in the tender document / schedule and generally, they can be in PDF / XLS / RAR formats. Bid documents may be scanned with 100 dpi with black and white option which helps in reducing size of the scanned document.
- iv) To avoid the time and effort required in uploading the same set of standard documents which are required to be submitted as a part of every bid, a provision of uploading such standard documents (e.g. PAN card copy, annual reports, auditor certificates etc.) has been provided to the bidders. Bidders can use "My Space" or "Other Important Documents" area available to them to upload such documents. These documents may be directly submitted from the "My Space" area while submitting a bid, and need not be uploaded again and again. This will lead to a reduction in the time required for bid submission process.

Note: My Documents space is only a repository given to the Bidders to ease the uploading process. If Bidder has uploaded his Documents in My Documents space, this does not automatically ensure these Documents being part of Technical Bid.



ISO 9001 Company

Heavy Engineering Corporation Limited
(A Govt. of India Enterprise)
Heavy Machine Building Plant
Ancillary & Contract Department

SUBMISSION OF BIDS

- i) Bidder should log into the site well in advance for bid submission so that they can upload the bid in time i.e. on or before the bid submission time. Bidder will be responsible for any delay due to other issues.
- ii) The bidder has to digitally sign and upload the required bid documents one by one as indicated in the tender document.
- iii) Bidder has to select the payment option as "offline" to pay the tender fee / EMD as applicable and enter details of the instrument.
- iv) Bidder should prepare the EMD as per the instructions specified in the tender document. The original should be posted/couriered/given in person to the concerned official, latest by as specified in the tender documents. The details of the DD / any other accepted instrument, physically sent, should tally with the details available in the scanned copy and the data entered during bid submission time. Otherwise the uploaded bid will be rejected.
- v) Bidders are requested to note that they should necessarily submit their financial bids in the format provided and no other format is acceptable. If the price bid has been given as a standard BOQ format with the tender document, then the same is to be downloaded and to be filled by all the bidders. Bidders are required to download the BOQ file, open it and complete the white coloured (unprotected) cells with their respective financial quotes and other details (such as name of the bidder). No other cells should be changed. Once the details have been completed, the bidder should save it and submit it online, without changing the filename. If the BOQ file is found to be modified by the bidder, the bid will be rejected.
- vi) The server time (which is displayed on the bidders' dashboard) will be considered as the standard time for referencing the deadlines for submission of the bids by the bidders, opening of bids etc. The bidders should follow this time during bid submission.
- vii) All the documents being submitted by the bidders would be encrypted using PKI encryption techniques to ensure the secrecy of the data. The data entered cannot be viewed by unauthorized persons until the time of bid opening. The confidentiality of the bids is maintained using the secured Socket Layer 128 bit encryption technology. Data storage encryption of sensitive fields is done. Any bid document that is uploaded to the server is subjected to symmetric encryption using a system generated symmetric key. Further this key is subjected to asymmetric encryption using buyers/bid openers public keys. Overall, the uploaded tender documents



ISO 9001 Company

Heavy Engineering Corporation Limited
(A Govt. of India Enterprise)
Heavy Machine Building Plant
Ancillary & Contract Department

become readable only after the tender opening by the authorized bid openers.

- viii) The uploaded tender documents become readable only after the tender opening by the authorized bid openers.
- ix) Upon the successful and timely submission of bids (i.e. after Clicking "Freeze Bid Submission" in the portal), the portal will give a successful bid submission message & a bid summary will be displayed with the bid no. and the date & time of submission of the bid with all other relevant details.
- x) The bid summary has to be printed and kept as an acknowledgement of the submission of the bid. This acknowledgement may be used as an entry pass for any bid opening meetings.

ASSISTANCE TO BIDDERS

- i) Any queries relating to the tender document and the terms and conditions contained therein should be addressed to the Tender Inviting Authority for a tender or the relevant contact person indicated in the tender.
- ii) Any queries relating to the process of online bid submission or queries relating to CPP Portal in general may be directed to the 24x7 **CPP Portal** Helpdesk.

Note: For any query related to registration and processing on the Portal please visit

FAQ available at

<https://etenders.gov.in/eprocure/app?page=FAQFrontEnd&service=page>

You may call the Helpdesk. The 24 x 7 Help Desk Numbers are
0120-4200462, 0120-4001002, 0120-4001005, 0120-6277787
E-Mail: support-eproc@nic.in

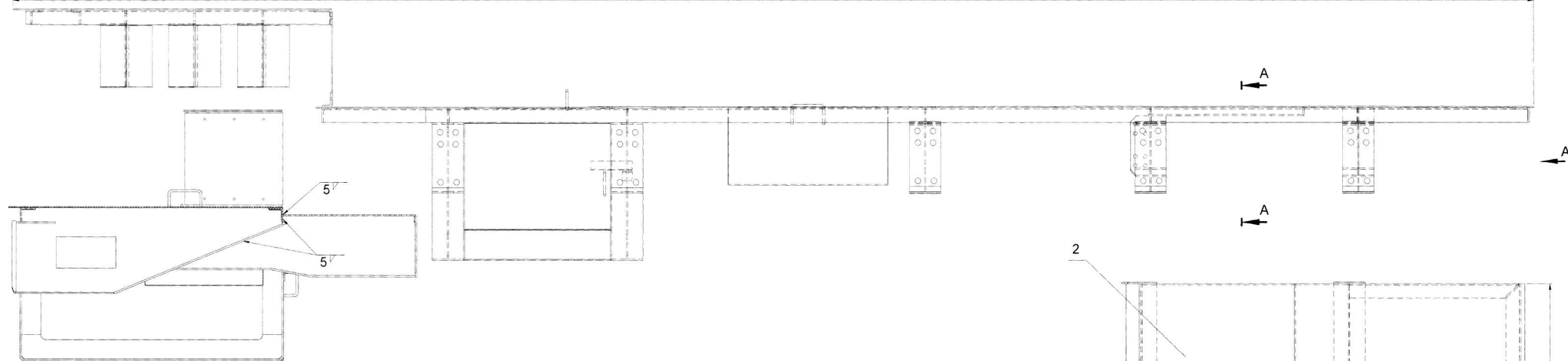

SECTION - A-A

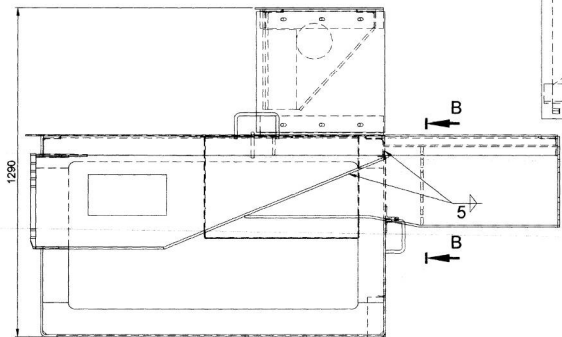
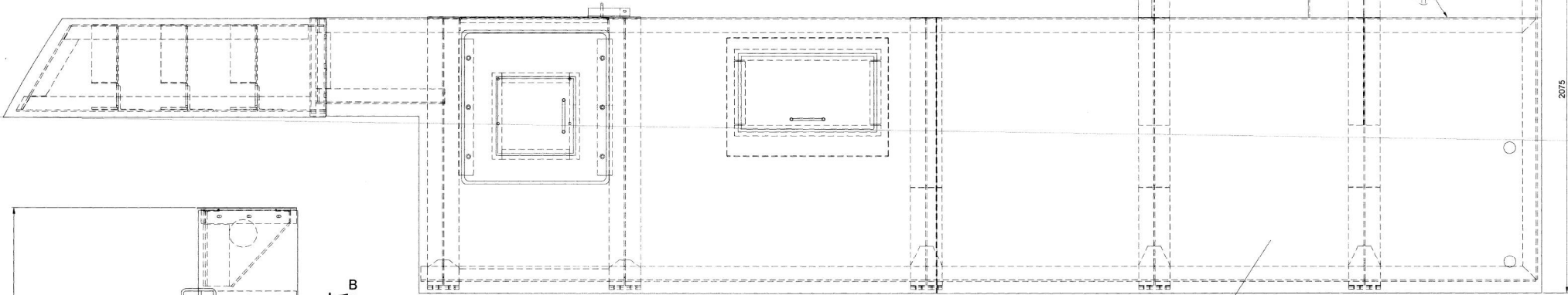

VIEW-A

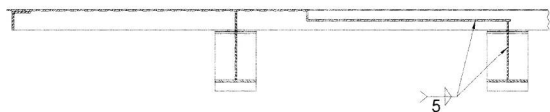

VIEW-B

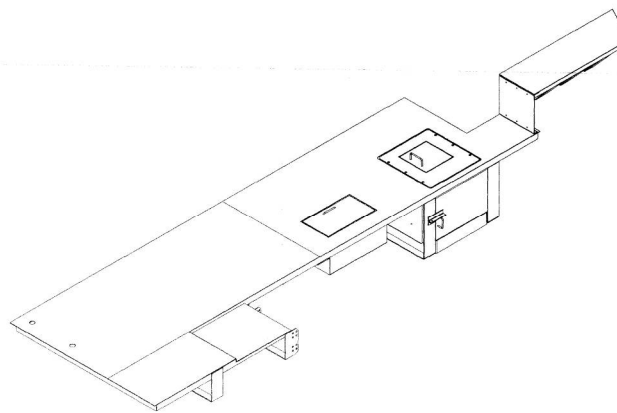

ISO VIEW

| INDEX NO. | DESCRIPTION | REVISION | SIGNATURE | DATE |
|-----------|-------------|----------|-----------|------|
| | | | | |

| 2 | 1050.07.531 | Extended Platform L.H. | Assly | 1 | 140.00 | 140.00 | |
|--|-------------|------------------------|-------------|---------|---------|-----------------------|----------|
| 1 | 1050.07.500 | Side Platform L.H. | Assly | 1 | 947.00 | 947.00 | |
| Item No. | Drawing No. | Description | Material | No. Off | Per pc. | Total | Remarks |
| | | | | | | | |
|  Platform L.H | | | | | | 1050.07.530 | |
| | | | | | | WEIGHT IN KG.-1087.00 | |
| | | | SCALE: 1:10 | | | | Dec. '20 |
| | | | | | H.M.B. | | Rev.-0 |
| REF ORG NO | DRAWN BY | HEC/RANCHI | | | | | |

1050.07.500

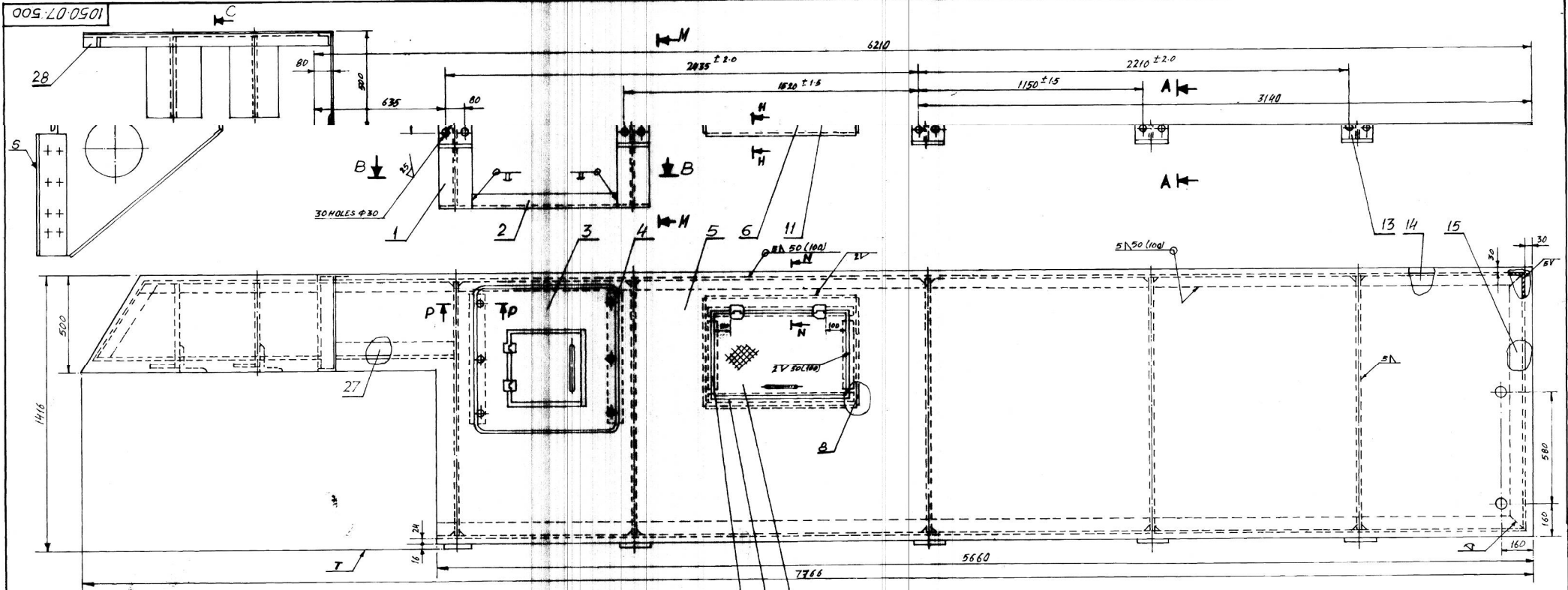

SECTION B-B

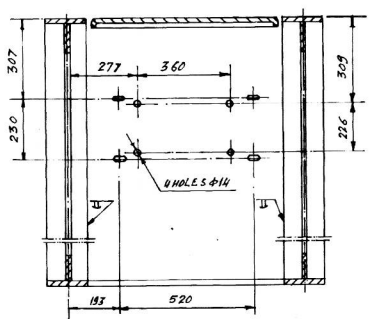

SECTION M-M

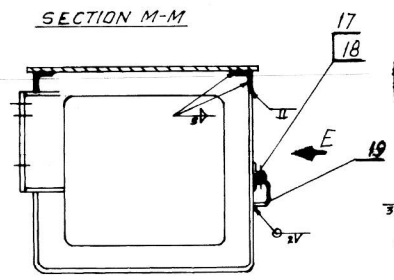

VIEW-E

SECTION A-A

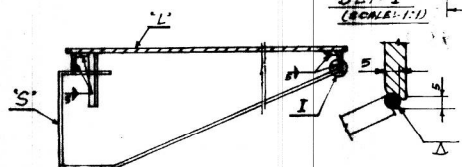

SECTION H-H

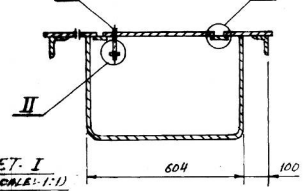

DET. I (SCALE: 1:1)

SECTION N-N (TURNED) (SCALE: 1:2)

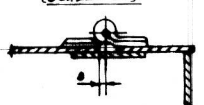

DET. II (SCALE: 1:1)

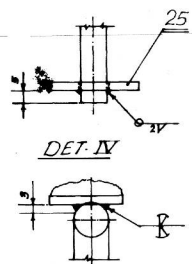

SECTION R-R (SCALE: 1:2)

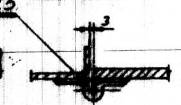

DET. III (SCALE: 1:1)

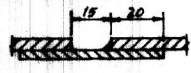

SECTION P-P (SCALE: 1:2)

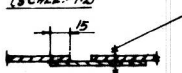

TECHNICAL INSTRUCTIONS

1. Manufacture and acceptance as per W.D. det.
 2. Use electrodes as per IS-1114-91 EN 8000 GROUP.

surface "L" is to be within 3mm.
 u. Min thickness of surface "T" to be within 5mm.

| | | | | | |
|----|-------------|------------------------------|----|-----------|--|
| 18 | 1050-07-505 | Top Frame Assy. | 1 | Assly | |
| 17 | 1050-07-338 | ISA 75 55x8, L=650 | 1 | No drg. | |
| 26 | 1050-07-337 | ISA 75 75x8, L=420 | 1 | | |
| 25 | - | Machined Washer 13 | 8 | 014-03-2 | |
| 14 | - | SL. C. S. Hd. screw M12 x 25 | 6 | 014-003-2 | |
| 23 | - | Hinge (M) 75, Unranked | 4 | 008-8334 | |
| 22 | 1040-07-336 | Bent sheet | 1 | | |
| 21 | 1040-07-335 | ISA 50 50x5, L=210 | 1 | | |
| 20 | 1040-07-334 | ISA 50 50x5, L=50 | 1 | | |
| 19 | 1040-07-338 | Handle | 1 | | |
| 18 | - | Hex Nut M12 | 7 | 014-001-3 | |
| 17 | - | Hex screw M12 x 40 | 1 | 014-003-9 | |
| 16 | 1040-07-311 | Bent rod Ø12 | 1 | | |
| 15 | 1050-07-333 | ISA 75 75x8, L=1330 | 1 | | |
| 14 | 1050-07-332 | ISA 75 75x8, L=6150 | 1 | | |
| 13 | 1050-07-328 | Bracket Assy | 3 | Assly | |
| 12 | 1050-07-339 | ISSH 3.20x5x2 | 2 | No drg. | |
| 11 | 1040-07-327 | Bent sheet | 1 | | |
| 10 | 1040-07-326 | ISSH 740x55x2 | 2 | No drg. | |
| 9 | 1050-07-325 | chgd. plate | 1 | | |
| 8 | 1040-07-324 | ISSH 600x397x2 | 2 | No drg. | |
| 7 | 1050-07-321 | ISA 50 50x5, L=250 | 14 | No drg. | |
| 6 | 1040-07-320 | ISA 75 75x8, L=5620 | 1 | | |
| 5 | 1050-07-391 | Base plate Assy | 1 | Assly | |
| 4 | 1040-07-316 | Packing | 2 | | |
| 3 | 1040-07-310 | Cover Assy | 1 | Assly | |
| 2 | 1050-07-303 | Plate | 1 | | |
| 1 | 1050-07-301 | Bracket Assy | 2 | Assly | |



SIDE PLATFORM
L.H.

1050-07-500

WEIGHT IN KG: 947.0

1050.07.531

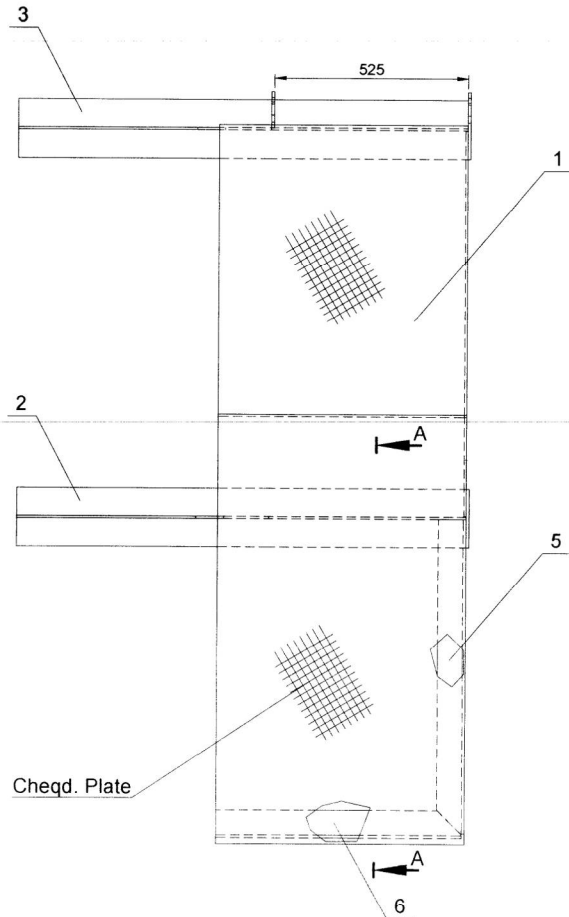
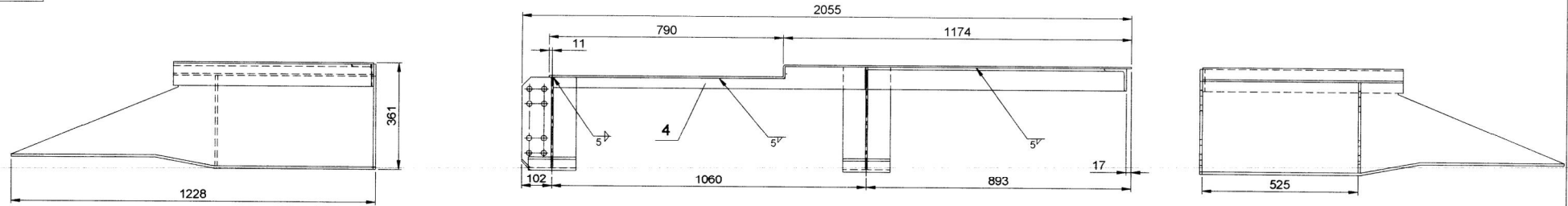

Cheqd. Plate

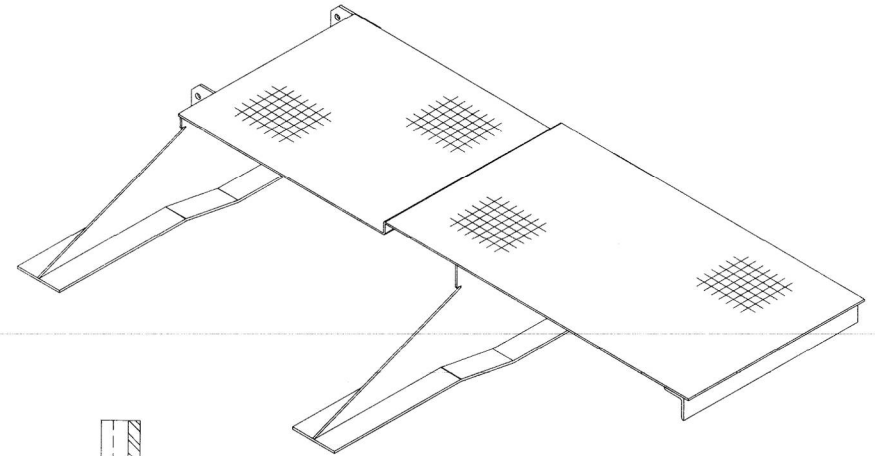

ISO VIEW

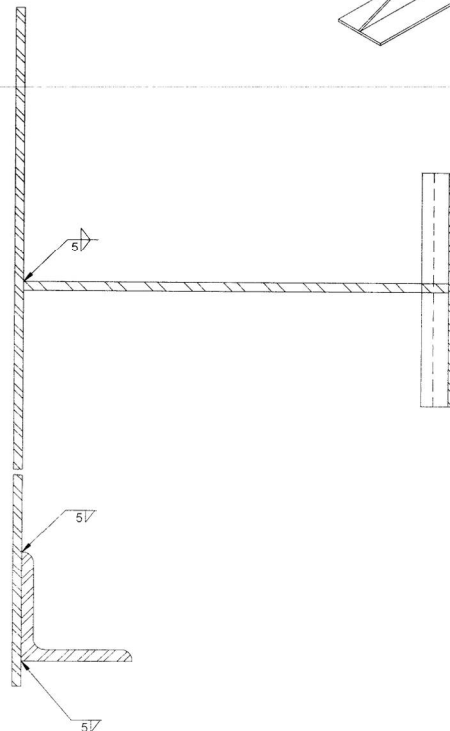

SECTION- A-A

Wt. of Weld Metal:-0.30Kg.

| Item No. | Drawing No. | Description | Material | No. Off | Per pc | Total | Remarks |
|----------|-------------|--------------------|-----------------------|---------|-----------|-------|---------|
| | | | | | Wt. in kg | | |
| 6 | 1050.07.543 | ISA 75 75x8, L=667 | Fe410WB IS.2062-92 | 1 | 6.00 | 6.00 | |
| 5 | 1050.07.542 | ISA 75 75x8, L=860 | Fe410WB IS.2062-92 | 1 | 7.50 | 7.50 | |
| 4 | 1050.07.541 | ISPL 1050x75x8 | Fe410WB IS.2062-92 | 1 | 2.30 | 2.30 | |
| 3 | 1050.07.537 | Bracket Assly | Assly | 1 | 30.10 | 30.10 | |
| 2 | 1050.07.533 | Bracket Assly | Assly | 1 | 30.00 | 30.00 | |
| 1 | 1050.07.532 | Chequered Plate | Fe410WB IS.2062-92 | 1 | 63.50 | 63.50 | |

Extended Platform L.H.
1050.07.531

HEAD OF DEPTT. R.J.PRASAD
 BUREAU-CHIEF A.DOSS
 CHECKED BY V.KUMAR
 DESIGNED BY A.PAL
 DRAWN BY M.KUMAR

SCALE- 1:10
 H.M.B.
 HEC LTD.,RANCHI

Jun. '20
 Rev.-0

WEIGHT IN KG.-140.00

| INDEX NO. | DESCRIPTION | REVISION | SIGNATURE | DATE |
|-----------|-------------|----------|-----------|------|
| | | | | |
| | | | | |
| | | | | |

