



एच॰ई॰सी॰

ISO 9001:2000

**HEAVY MACHINE BUILDING PLANT  
HEAVY ENGINEERING CORPORATION LIMITED**

(A Govt. of India Enterprise)

Ranchi – 834 004 (INDIA)

Tender Enquiry No. PUR/HMB/2019/962044/EL-5944

Date: 30.12.2019

**Open Tender Enquiry(E-Tender) for**  
**Procurement of 01 set of CONTROL ELECTRICS OF 50/12.5Tx20.1M**  
**CRANE, FFP/HEC LTD.RANCHI**

This tender has seven parts as detailed below, Please read carefully the tender document before submitting the offer. In case, any clarification is required, it should be mailed to [babloosoni@hecltd.com](mailto:babloosoni@hecltd.com) / [pkasingh@hecltd.com](mailto:pkasingh@hecltd.com):

SL No.	Description	Page range
1	Introduction	2-4
2	Annexure-A (Important Points & Commercial Terms & Conditions)	5-11
3	Annexure-B (Commercial Check List)	12-13
4	Annexure-C (Format of EMD BG)	14-16
5	Annexure- D (Format of Security Deposit)	17-20
6	Annexure- E (Format of PBG)	21-22
7	Annexure-F (Instructions for Online Bid Submission)	23-25
8	Annexure-G (Technical Specification)	26-77
9	BOQ/Price Bid format(Uploaded separately in the E- tender portal)	

**Note:**

- i. Any corrigendum in the E-Tender Enquiry shall be notified at [www.etenders.gov.in](http://www.etenders.gov.in) only.
- ii. **Offer has to be submitted only online** at E-tender Portal: [www.etenders.gov.in](http://www.etenders.gov.in). Offers submitted in Hard copy shall not be considered, however tender Cost, Earnest Money Deposit (Original Demand Draft/bank Guarantee) may be submitted to us in hard copy separately so as it reaches to us before due date of opening of Tender.
- iii. Scan copy of tender Cost & EMD to be uploaded in part-1 of offer i.e techno-commercial bid.



एच॰ई॰सी॰

ISO 9001:2000

**HEAVY MACHINE BUILDING PLANT  
HEAVY ENGINEERING CORPORATION LIMITED**

(A Govt. of India Enterprise)

Ranchi – 834 004 (INDIA)

Tender Enquiry No. PUR/HMB/2019/962044/EL- 5944

Date: 30.12.2019

**OPEN TENDER ENQUIRY****Sub: E-tendering with E-price bids for procurement of Control electrics for 50/12.5Tx20.1M DG E O T Crane.**

Tenders are invited on line through website. Tenders are to be submitted strictly as per guidelines furnished in the website of <http://etenders.gov.in> here under:

**INSTRUCTION TO BIDDERS (ITB)****1.0 Tender Summary :**

Tender Ref No.	PUR/HMB/2019/962044/EL-	dated 24.12.2019
Cost of Tender documents / Tender Fee (Exempted for NSIC/SSI/MSME registered firms)	Rs.1500.00 in favor of "Heavy Engineering Corporation Limited "Payable at Ranchi.(To be submitted in form of DD" to the undersigned through courier/By Hand )	
Earnest Money Deposit	Rs.3,00,000.00 in favor of "Heavy Engineering Corporation Limited "Payable at Ranchi.(To be submitted in form of DD" to the undersigned through courier/By	
Mode of Tender:	E tender with e price bid	
Type of tender	Two Bid tender	
Last date and time for on-line submission of tender	20.01.2020	UPTO 13 Hrs (IST)
Due date and time for on line opening of tender :	22.01.2020	AT 15 Hrs (IST)
(Under unforeseen circumstances and if the due date falls on holiday, the tender will be opened on the next full working day at same time		

*Bidders are requested to submit their most competitive offer through e- procurement mode only. Offer submitted through offline mode will not be considered. For more information please visit our website <https://etenders.gov.in/eprocure/app>.*

*Prospective Tenderers are advised to get registered themselves only on at NIC tender portal i.e. <https://etenders.gov.in/eprocure/app>, obtain 'User ID' & 'Password' and go through the 'Self Help files' available in the Home Page after log in to the portal <http://etenders.gov.in>. They should also obtain Class III Digital Signature Certificate (DSC) in parallel which is essentially required for submission of their application. A detailed instruction for online bid submission is mentioned below. No registration fee would be charged from the bidders.*

*Bidders are required to upload the bid along with all supporting documents including priced part (BoQ) only on the e-tendering website*



एच॰ई॰सी॰

ISO 9001:2000

**HEAVY MACHINE BUILDING PLANT  
HEAVY ENGINEERING CORPORATION LIMITED**

(A Govt. of India Enterprise)

Ranchi – 834 004 (INDIA)

(<https://etenders.gov.in/eprocure/app>), on or before the due date and time for submission of bid.

NOTE:

1. HEC reserves the right to extend / change the schedule of any activity by intimating the bidders through a notification on the e-tender portal.

2. For detailed guidance for online bid submission, please refer annexure-D.

**2.0 Contents of tender documents:**

1	Technical specification & Commercial Terms and Conditions of NIT	Annexure "A" Annexure 'B' & Annexure 'G', respectively.
2	Template for Price format/BOQ for online submission by the bidder	BOQ.xls

Requirements for Vendors:

- A) P.C. connected with internet.
- B) Registration with Service provider portal <https://etenders.gov.in>
- C) The vendor should possess a Class-II or Class III Digital Signature certificate (Mandatory). (Bids will not be recorded without Digital Signature Certificate.)
- D) In case of any clarification please contact M/s NIC, before the schedule time of the submission of bid. Contact Person:- **Shri Kushal Kumar: 09852923855 / 7903884318**
- E) Registration / Enrollment of Bidder on e- tender Portal of HEC: In order to submit the bid, the bidders have to get themselves registered online on the e- tender portal of HEC Ltd with valid Digital Signature Certificate (DSC ) issued from any agency authorized by CCA and which can be traced upto the chain of trust to the Root Certificate of CCA. The online Registration of the Bidders on the portal will be free of cost and one time activity only. The registration should be in the name of the bidder, whereas DSC holder may be either bidder himself or his duly authorized person.

**3.0** For **registration**, Submission procedure and method of correspondence etc. Please visit our website: <https://www.hecltd.com> / <https://etenders.gov.in> and click on the relevant link for help.

**4.0 Help for participating in e-tender:**

The detailed method for participating in the e-procurement are available in the website <https://www.hecltd.com> or <https://etenders.gov.in> The bidders have to Log on to official website and then click on the specified links to start participating in the e-procurement process.

Bidders are also free to communicate with the contact person of the service provider to get all clarifications regarding the mode of the e-procurement process.

NB:

- (I) Please note that there is no provision to take out the list of parties downloading the tender document from the above referred web site. As such, tenderers are requested to see the website once again before due date of tender opening to ensure that they have not missed any corrigendum uploaded against the said tender after downloading the tender document. The responsibility of downloading the related corrigenda, if any, will be that of the



एच०ई०सी०

ISO 9001:2000

**HEAVY MACHINE BUILDING PLANT  
HEAVY ENGINEERING CORPORATION LIMITED**

(A Govt. of India Enterprise)  
Ranchi – 834 004 (INDIA)

- downloading parties.
- (II) No separate intimation in respect of corrigendum to this NIT( if any ) will be sent to tenderers who have down loaded the documents from website. Please see website i.e., <http://www.hecltd.com> or <http://www.etenders.gov.in>
- 5.0** The offer should be submitted (uploaded) strictly as per the terms and conditions and Procedures laid down in the website <https://etenders.nic.in> tender document failing which the offer is liable for rejection.  
Bidders should download the complete NIT including the Annexure and read carefully before filling the details and uploading the documents.
- 6.0** The offers with any deviations to the NIT Terms and conditions shall be liable for rejection.
- 7.0** The bidder must upload all the documents required as per the terms of NIT. (Any other document uploaded which is not required as per the terms of the NIT shall not be considered.)
- 8.0** It may please be noted that E-tendering or e-procurement fall under the purview of the Information Technology Act 2000 and Information Technology (Amendment) Act 2008 and other relevant acts and subsequent amendments if any).
- 9.0** There will be no physical sale of the tender documents.
- 10.0 PREPARATION OF TENDER DOCUMENTS :**  
Tender is to be submitted in **TWO BID** system in the following manner and shall be submitted through electronic mode only as detailed below:

- a. Techno-commercial offer (Part-1) – The offer are to be scanned and uploaded in our portal consisting technical details as per annexure-G & Commercial terms & conditions as per annexure-A. The format as per Annexure-B (Commercial sheet.pdf) to be downloaded and the same to be duly filled by the bidder and to be uploaded while submitting the offer. **No price part is to be uploaded in this part.**
- b. Price-format/BOQ (Part-II): This part of the offer should contain price portion. The format of Price Bid/BOQ in excel format has to be downloaded by the bidder and rate offered by the bidder shall be filled in the excel file and uploaded the same excel file of e tendering system while submitting the offer.  
The price-format/BOQ which is incomplete and not submitted as per the instructions given will be liable for rejection.

Note :

Bidders are requested to upload all the attachments /documents in one single PDF File in Other Important Documents (OID) or as indicated in the online instructions. For Example if more than one document is to be uploaded in support of Eligibility criteria or proven-ness criteria or any other requirement then bidder must prepare one single PDF file of all the related documents and then upload in the system in OID

**11.0 Please read carefully before you quote: -**

**Last date of Receipt of Tender Document: by 1:00 PM (IST) on 20.01.2020**

**Due date of tender opening (Part-1): at 3:00 PM (IST) on 22.01.2020**

- 12.0 Disclaimer clause:-**The Company (Heavy Engineering Corporation Ltd.) nor the service provider ([www.etenders.gov.in](http://www.etenders.gov.in)) is responsible for any failure of submission of bids due to failure of internet or other connectivity problems or reasons thereof.



एच.ई.सी.

ISO 9001:2000

**HEAVY MACHINE BUILDING PLANT  
HEAVY ENGINEERING CORPORATION LIMITED**

(A Govt. of India Enterprise)

Ranchi – 834 004 (INDIA)

**Annexure A****1.0 SCOPE OF SUPPLY & WORK: -**

This tender specification calls for turnkey execution of the job covering the design, engineering, manufacture, handling (loading and unloading), supply FOR HMBP stores at Ranchi, transportation from purchaser's store at FFP, HEC site to crane erection site, erection, testing, commissioning of electrics with standard accessories and attachment as covered in this specification as well as enclosed GA diagram Nos. **3339.20.000** and demonstration of performance guarantee parameters of the equipment / system in a coordinated and integrated manner as per the relevant clauses of the specification. Detailed technical specification and scope of work( Supply & Services) will be as per enclosed Annexure- G.

The following are the lists of cranes for Steel Melting Shop (02 shop) of FFP, Ranchi.

Sl. No.	Description	Qty	Location	Remarks
<b>EOT Cranes in 02 Shop (SMS)</b>				
1.	50/12.5T x 20.1 M	1	02 SHOP, FFP	

**Important Points:**

1. Bidders are requested to go through tender document in detail before submitting their offer.
2. **INSTRUCTION TO THE TENDERERS:**
  - a. This specification shall be read in conjunction with Indian standards and IPSS.
  - b. This specification covers design, engineering, manufacture, fabrication, assembly, shop testing, painting, supply, handling (loading and unloading) of materials and transportation from purchaser's store at FFP/ HEC site to crane erection site, erection, testing and commissioning of electrics for Double Girders EOT cranes complete with all accessories & attachments as per this specification and enclosed crane GA drawings and demonstration of performance guarantee parameter of the equipment/system in a coordinated and integrated manner as per the relevant clauses of the specification.
  - c. Tenders shall be accompanied with the information as required in cl 07.01. Tenders may be rejected if all informations required are not furnished while tendering. The tenderer shall clearly specify any request for deviation from technical specifications in the format enclosed at Annexure II. Deviation indicated elsewhere other than the enclosed format will not be considered.
  - d. The Tenderer shall submit a time bar chart along with the tender indicating starting and completion dates showing breakup of time required for various activities along with schedule of erection, testing and commissioning of the Electrics for the cranes.
  - e. Drawings as per cl. No. 07.02 shall be submitted in 6 sets for each crane to the Purchaser in



एच०ई०सी०

ISO 9001:2000

**HEAVY MACHINE BUILDING PLANT  
HEAVY ENGINEERING CORPORATION LIMITED**

(A Govt. of India Enterprise)

Ranchi – 834 004 (INDIA)

stages for approval / reference within one month of issue of Letter of Intent and prior to commencement of manufacturing. The Purchaser shall send his comments within 15 days of receipt of the drawings. However, approval of drawings by the Purchaser will not relieve the supplier of his responsibilities for correctness, adequacy of the design and completeness of his work as per the contract. Approval of drgs. from FFP. Any minor change during approval stage shall be the responsibility of the tenderers and same shall be incorporated without any price implication.

All the drgs. and documents will be in English Language. Drawings shall be complete in all respect with dimensions, item lists, weights, sub-supplier's name etc.

- f. The supplier shall furnish 6 sets of prints of all drawings per crane as per Cl. No. 07.03 of annexure C.
- g. If the drawings and other particulars are returned, because they are incomplete or incorrect, the Supplier shall not be given any extension of time on this account.
- h. The supplier shall furnish adequate nos. of prints of all erection drawings as showing the mark numbers with weights of the various items to be assembled at site.
- i. The documents supplied prior to commissioning of the crane.
- j. The following documents shall be supplied prior to commissioning of the crane.
  - i) Soft copy with hard copy of all drawing and data which have been approved by the purchaser.
  - ii) Soft copy along with hard copy of erection, testing, commissioning and operating manuals, electrical circuit diagrams, catalogues of all electrical equipments, technical specification, catalogues and technical manuals of all bought out items etc and information on special features.
- k. The no load test of Crane Bridge and trolley shall be carried out separately at site in presence of purchaser's representative; over load and rated load test of the cranes and hoists shall also be carried out at site.
- l. Construction power shall be provided free of cost at one point within the shop (within 300m) tenderer shall lay necessary cables up to erection site for their requirement.
- m. The supplier shall submit test certificates for all electrical equipments & cables.
- n. The following test shall be carried out at manufacturer's premises during inspection.
  - High voltage test of panels.
  - Integrated panel testing
  - Routine test for all motors shall be carried out at motor manufacturer's premises.
- o. All the electrical equipment shall be of reputed make and proven quality with regard to their performance. The make shall be as per approved list of FFP. However, makes of items not included in the preferred make list shall be subjected to approval by FFP. Makes of major components like VFD & motors being considered by the tenderer shall be furnished with the offer.
- p. The equipments shall be offered for inspection and testing during different stages of its manufacture, starting from raw materials till completion by the purchaser / his authorized representative at the Supplier's or his sub-supplier's works as per the inspection procedure mutually agreed. Inspection shall be regarded as a check up and shall be in no way binding on the purchaser.



एच०ई०सी०

ISO 9001:2000

**HEAVY MACHINE BUILDING PLANT  
HEAVY ENGINEERING CORPORATION LIMITED**

(A Govt. of India Enterprise)

Ranchi – 834 004 (INDIA)

- q. Documents for all electrical equipment supplied with the crane shall be put up for inspection along with the equipment.  
After inspection, an endorsement would be made in the inspection certificate about the availability of the documents.
- r. **Ability and Experience of the Tenderer**
- i) The Tenderer shall satisfy the Purchaser that he possesses necessary technical know-how and facilities to execute the order. Necessary particulars to establish the same shall be furnished along with the tender.
  - ii) Reference list of similar job executed elsewhere during last five years (client's address, purchase order no., date of placement of order, schedule delivery period vs actual delivery period, annual audited report for last 5 years with literature/ catalogues of previous supply.
  - iii) A write-up on testing facilities available in the manufacturer's works shall be furnished by the Tenderer.
- s. Necessary clearance from statutory authorities (if any) shall be obtained before the cranes are put under operation immediately after the cranes are commissioned. The crane after erection shall be tested as follows:
- i) Insulation tests and other tests mentioned shall be carried out as per the latest IS: 3177 & IS: 4137 (as applicable).
  - ii) Speed Tests :
    - a) All motion of the crane shall be tested with rated load on all notches at the time of commissioning of the crane at site and the speeds shall be attained within the tolerance limit.
    - b) All motions of the crane shall be tested with 25% over load in which case the specified speeds need not be attained but the crane shall show
- t. **LIST OF PREFERRED MAKES OF ELECTRICAL PARTS:**
- The make of the equipments shall be as per the preferred make list of FFP/HEC. Makes of item not included in the list shall be subject to approval by FFP/HEC (Enclosed in annexure G)
- u. **Information to be furnished by the Tenderer along with the offer:**
- The Tenderer shall submit following technical drawings & technical data/ information with tender for cranes without which the tender shall be considered as incomplete & may not be considered for acceptance.
- a. The technical specification duly stamped and signed as a token of acceptance.
  - b. Deviations from tender documents in the format enclosed as per Annexure- II.
  - c. List of commissioning spare & list of spares for two (2) years normal operations for each crane as per clause no 03.01 and 03.02.
  - d. Other supporting documents as per clause no. 04.18 i, ii & iii.
  - f. Un-priced copy of list of equipment.





एच०ई०सी०

ISO 9001:2000

**HEAVY MACHINE BUILDING PLANT  
HEAVY ENGINEERING CORPORATION LIMITED**

(A Govt. of India Enterprise)

Ranchi – 834 004 (INDIA)

- g. Motor & Component list.
- h. Technical details of AFE converters, VFDs etc.
- i. Single line diagrams / Block Diagram of control panels, AFEs, VFDs, LDBs etc.
- j. Connected load and 30 minute maximum demand.
- k. List of Makes.
- l. Motor GA drg. & motor datasheet.

**Important Points:**

3. Bidders are requested to go through tender document in detail before submitting their offer.

**Commercial terms and conditions:**

1. Offers to be submitted on FOR HMBP Stores basis. The rate quoted shall be inclusive of all packing & forwarding, freight and transit insurance charges. **If quoted on Ex Work's basis then Freight charge to be clearly notified otherwise offer may not be accepted..**
2. **The Price quoted by the tenderer should be exclusive of GST.** The rate and nature of GST applicable should be shown separately GST will be paid to the seller at the rate at which it is liable to be assessed or has actually been assessed on the date of supply provided the transaction of sale is legally liable to GST and within the delivery period.
3. The rates quoted must be firm and the offers made must remain open for acceptance for minimum 120 days from the date of opening of the tender.
4. **Payment terms shall be as under:**

<b>For supply of total materials</b>	<p>90% of basic order value of supply part along with 100% GST shall be released through RTGS within 60 days of receipt of materials along with Guarantee certificate ,test certificate inspection certificate /CRV( To be issued by HEC) ,original invoice &amp; Performance bank guarantee of 10% of total order value to be valid till full guarantee period from any nationalized bank only in HEC's Format."</p> <p><b>Submission of bills:</b> Following documents are required to be submitted for processing of payment after receipt of material at our stores/HMBP:</p> <ol style="list-style-type: none"> <li>a. Copies of Receipted Lorry Consignment Note.</li> <li>b. Copies of Packing List &amp; Delivery Challan including originals.</li> <li>c. Copies of Inspection Certificate including originals.</li> <li>d. Dispatch clearance issued by PURCHASER.</li> <li>e. Original copy i.e. Buyer's copy of Invoice as per GST Norms.</li> <li>f. Documentary evidence regarding handing over of Transporter copy of Tax Invoice to the Site /Stores of PURCHASER.</li> <li>g. Material Test Certificate.</li> <li>h. Performance bank Guarantee for 10% of total order value.</li> <li>i. Certificate from the supplier that the contents in each case are not less than those entered in the invoice and packing list and the quality of goods are guaranteed as new and as per the Relevant technical specification.</li> </ol> <p><b>Balance 10% of supply part shall be released within 30 days after submission of completion certificate of erection from HEC.</b></p>
<b>FOR erection &amp; commissioning Charges</b>	100% payment for erection & commissioning charges along with 100% GST shall be released within 30 days after submission of successful commissioning certificate issued by HEC.





एच०ई०सी०

ISO 9001:2000

**HEAVY MACHINE BUILDING PLANT  
HEAVY ENGINEERING CORPORATION LIMITED**

(A Govt. of India Enterprise)

Ranchi – 834 004 (INDIA)

**Note:**

- i. For payment all the processing charges by the bank shall be on account of the firm.
  - ii. If you offer any other payment terms other than NIT payment terms then your offer can be loaded with bank interest rate ( Presently 1% per month i.e 12% per annum (Maximum ) as per the rules of the company for L1 consideration only.
5. Quotations erased or over written are likely to be rejected unless all corrections are authenticated with the tenderer's signature.
  6. **Schedule for drawing submission, Delivery of materials & "Erection & Commissioning of supplied electrics " at site :**

<b>Drawing/Documents submission for approval after placement of PO as per Clause 7.02 &amp; 7.03 of technical specification i.e Annexure C of NIT.</b>	Total drawings as per clause No. 7.02 & 7.03 of technical specification (annexure-G) shall be furnished within one month from the date of receipt of PO.
<b>Delivery of materials</b>	Firm will raise inspection call within 3 months maximum from the date of approval of drawings /manufacturing Clearance from HEC. Material shall be delivered to Stores/HMBP within 15 days after issuing dispatch clearance.
<b>Erection , testing &amp; Commissioning at site</b>	Supplier shall depute their engineers at site for Erection, Testing & Commissioning of supplied material within maximum 5-7 days from the date of intimation from HEC for site availability. <b>Note: It will be supplier's responsibility to make the manpower available at site for Erection &amp; Commissioning till the completion of Erection &amp; commissioning of all supplied materials without any extra cost implication other than quoted charges for "Erection &amp; Commissioning" at site.</b>

7. Full particulars i.e. specification, literature and / or drawing wherever applicable has to be submitted along with the quotation. The '**Brand**' and '**Make**' name must be indicated.
8. **Tender Cost of Rs.1500.00:** Bids must be accompanied by a Tender cost (Bid Security) amounting to Rs.1500/- in the form of demand draft in favour of "Heavy Engineering Corporation Limited" and payable at par at Ranchi alongwith techno-commercial bid. (Scan copy of DD to be uploaded along with techno-commercial bid & original DD to be sent through courier / submitted by hand to the office of undersigned.
9. **Earnest Money Deposit -** Earnest money Rs. 3, 00,000.00 will have to be deposited in form of demand draft / bank guarantee (format is enclosed at annexure-C) from any nationalized bank Payable on the State Bank of India, Ranchi Hatia Branch, in favor of Heavy Engineering Corporation Ltd. Ranchi. - 4. . (Scan copy of DD to be uploaded along with techno-commercial bid & original DD to be sent through courier / submitted by hand undersigned.  
**Note: No EMD / Tender Document Cost shall be required under the following cases, if the firm is registered with:**
  - a) **National Small Industries Corporation / Small Scale Industries / Micro, Small-scale Enterprises (MSE), as per Government directive \***.
10. The Corporation does not pledge itself to accept the lowest or any tender and reserves to itself the right of accepting the whole or any part of tender or portion of the quantity offered and you shall supply the same at the rate quoted.
11. Supplies will be subject to Inspection by our Inspection wing / or inspection Agencies prescribed by us.



एच०ई०सी०

ISO 9001:2000

**HEAVY MACHINE BUILDING PLANT  
HEAVY ENGINEERING CORPORATION LIMITED**

(A Govt. of India Enterprise)

Ranchi – 834 004 (INDIA)

12. Order placed as a result of this tender will be subject to the Corporation's General Terms and Conditions of contract which can be down loaded from our website ([www.hecltd.com](http://www.hecltd.com)).
13. Corporation reserves the right to call for and examine at any time the books of accounts and other documents and papers of the firm for the purpose of ascertaining whether any excess payments has been made or the firm likely to be received / received undue benefit out of execution of the particular contract.
14. The final quantity may vary at the time of finalization of tender; however the proper clarification / confirmation shall be taken from the firms.
15. Delivery: The time for and the date of delivery of the Stores stipulated in the acceptance of tender shall be deemed to be the essence of the contract and delivery must be completed not later than the dates specified therein. Otherwise:
  - a) **LD & Risk Purchase Clause** - The purchaser to recover from the contractor a sum of 0.5 % per week (completed week) of the price of the stores(upto maximum 10 %) as liquidated damages, which the contractor has failed to deliver as aforesaid or,
  - b) The purchaser may procure the undelivered stores / similar items from elsewhere, without notice to the contractor at the risk of the contractor without canceling the contract in respect of the consignment not yet due for delivery or,
  - c) To cancel the contract or a portion thereof.
16. Tenderers registered with National Small Industries Corporation/ Small Scale Industries/ Micro, Small scale Industry (MSE) or DGS&D for the tendered item will be exempted from submission of EMD. The tenderer should enclose an authenticated copy / notarized copy of their valid registration certificate with NSIC, MSE for grant of exemption.  
**In case Bidder is covered under MSME criteria, it is mandatory to quote UAM no in Bid Documents.**  
**HEC is registered on TReDS governed by RBI Guidelines and our registration no is HE0000320. All MSME firms are advised to be get registered on RXIL (Receivable exchange of India-Mumbai)**
17. **Guarantee** – The materials supplied shall be guaranteed for a period of 12 months from the date of commissioning or 18 months from date of supply whichever is earlier.
18. **Security Deposit**- 5% of the P.O. value to be deposited by the successful bidder within 21 days after placement of order by HEC which shall remain with HEC till the completion of order by the firm. This clause is mandatory and has to be accepted by all bidders. **If Security deposit clause is not accepted then the offer of the bidder shall not be considered.(Format is enclosed at annexure-D)**
19. **Performance bank guarantee (BG format annexure E)**: The successful bidder has to submit the performance bank guarantee of 10% of order value valid till full guarantee period after supply of the material. (In case order placed on the firm).
20. Based on HEC's requirement and in order to ensure security of supply from more than one sources, the total tendered quantity of any item may be split amongst more than one successful bidder at L1 Landed price. Hence Purchase Order may be placed on more than one firms and the repeat order for 100% quantity may be placed on successful bidder.
21. Risk Purchase Clause – If the material is not supplied within the stipulated period then material can be procured at the risk & cost of the firm without giving any notice to the firm.
22. There is no obligation on our part to accept delayed / late tenders. Tenders received after the due date of opening are liable to be summarily rejected.
23. **General conditions of the contract** :Unless otherwise specified in the Terms & Conditions above, this order shall be governed by General conditions of contract of purchase of HEC Ltd, which is available in the web site of HEC. ([www.hecltd.com](http://www.hecltd.com))

**Special Note:**

While submitting tender pl. mention your Registration No. with HEC as a registered vendor with valid paper.



एच॰ई॰सी॰

ISO 9001:2000

**HEAVY MACHINE BUILDING PLANT  
HEAVY ENGINEERING CORPORATION LIMITED**

(A Govt. of India Enterprise)

Ranchi – 834 004 (INDIA)

If not pl. get registered your firm with HEC Limited immediately.

Please indicate whether your firm covered under MSES/MSES owned by SC/ST or MSE Owned by Women covered under SSI separately in Techno-commercial bid.

Please submit the form of Terms & Conditions duly filled in and signed by the tenderer along with your offer in technical (part-1) bid.

**24. Law Governing contract-**

(1) This contract shall be governed by the laws of India for the being in force.

(2) Irrespective of the place of delivery, the place of payment under the contract, the contract shall be deemed to have been made at the place from which the acceptance of tender has been issued.

(3) Jurisdiction of Courts: The court of the place from where the acceptance of tender / purchase order has been issued shall alone have jurisdiction to decide any dispute arising out of or in respect of the contract,

(4) Marking of Stores: The marking of the stores must comply with the requirements of the laws relating to Merchandise Marks for the time being in force in India.

**25. ARBITRATION**

In the event of any dispute or difference of opinion between the Heavy Engineering Corporation or any of its units / division and the contractors as to the respective rights and obligation of the parties hereafter or to the true intent and meaning of these presents and the many articles of conditions thereto, such dispute of difference of opinion shall be referred to the many articles of conditions thereto, such dispute of difference of opinion shall be referred to the sole arbitration of the Chairman, Heavy Engineering Corporation and his decision shall be final, conclusive and binding on the parties.

**26. Mode of dispatch:**

By Road to the consignee at In-charge stores /HMBP/HEC Ltd. Ranchi. For the consignments dispatched by road, the supplier shall ensure that the following are observed by them:

i) All dispatches must be affected only on receipt of written dispatch clearance from the purchaser.

ii) Material shall be dispatched to In-charge stores/HMBP/HEC Ltd, Ranchi.

iii) Care shall be taken to avoid damages during transit to ensure that all the packages are firmly secured.



एच०ई०सी०

ISO 9001:2000

**HEAVY MACHINE BUILDING PLANT  
HEAVY ENGINEERING CORPORATION LIMITED**

(A Govt. of India Enterprise)

Ranchi – 834 004 (INDIA)

**Annexure B****(To be filled by bidder and scan copy of the same to be uploaded along with Techno-commercial bid)**

Sl No.	Terms & Conditions	Desired BY HEC	Bidders Comment ( Accepted / Not accepted )	Remarks
1	Scope of supply & services as per NIT	Must be accepted		
2	Price Term (Ex-Works / FOR HMBP)	FOR HMBP Stores		
3	Packing and Fwd. (Extra/Included/Not Applicable)	To be included in quoted price. If not included then clearly indicate amount.		
4	GST Registration certificate	To be furnished		
5	TAXES (GST )	% of Applicable Taxes to be indicated Extra		
6	Payment Terms	To be confirm in line with NIT Clause No.4 of NIT's annexure-A		
7	Validity of Offer	Minimum 120 days from the date of opening of tender		
8	Price Variation Clause	Prices will be firm till the Complete execution of order. (To be confirmed).		
9	Delivery Schedule	To be confirmed as per Clause no. 6 of Annexure-A		
10	Inspection	By QCA/HMBP		
11	Tender Cost of Rs.1500 .00 ( Mandatory) as per clause No. 8 of annexure-A	DD from any nationalized bank in favor of HEAVY ENGINEERING CORPORATION LIMITED, payable at Ranchi ( <b>Exempted for NSIC/SSI /MSME registered firms</b> )		
12	Freight Charges if Ex-Works	Must be indicated otherwise offer may not be accepted.		
13	EMD of Rs. 3,00,000.00 ( Mandatory) as per clause No. 9 of annexure-A	DD from any nationalized bank in favor of HEAVYENGINEERING CORPORATION LIMITED, payable at Ranchi ( <b>Exempted for MSME/NSIC/SSI registered firms</b> )		
14	Security Deposit for 5% of PO value as per clause No. 18 of annexure -A	To be deposited by successful bidder within 21 days after placement of order by HEC. <b>This clause is mandatory and has to be accepted by the bidder. . If Security deposit clause is not accepted then the offer of the bidder shall not be considered.</b>		



एच०ई०सी०

ISO 9001:2000

**HEAVY MACHINE BUILDING PLANT  
HEAVY ENGINEERING CORPORATION LIMITED**

(A Govt. of India Enterprise)

Ranchi – 834 004 (INDIA)

15	Performance bank guarantee for 10% of order value as per clause No. 19 of annexure-A	Bank Guarantee for performance from any nationalized bank in favor of HEAVY ENGINEERING CORPORATION LIMITED, Ranchi as per tender enquiry. <b>This clause is mandatory and has to be accepted by the bidder. If PBG clause is not accepted then the offer of the bidder shall not be considered.</b>		
16	Guarantee/Warranty Certificate as per clause No. 17 of annexure-A	<b>To be provided</b> ( 12 months from the date of installation/commissioning or 18 months from the date of supply & acceptance of materials at consignee's end whichever is earlier)		
17	L/D Clause Acceptable (Yes/No)	To be Accepted (As per NIT's annexure-A)		
18	Special terms (If Any)			
19	Acceptance of Risk Purchase Clause (Yes/No)	To be Accepted as per NIT's annexure-A		
20	GCC of HEC (available in tender section at HEC website : www.hecltd.com)	To be accepted as per NIT's annexure-A		
21	Confirmation of Supplying the materials as per Enquiry Schedule	YES/ NO		
22	All NIT conditions are acceptable	Yes/No, if no then state the clause wise deviation		
23	If firm is owned by SC/ST Entrepreneurs	To be indicated		
24	UAM (Udyog Aadhar No) No if registered under MSME	To be mentioned by bidder if applicable		
25	Materials shall be manufactured & supplied in line with in adherence of QMS/EMS/OHSAS	To be confirmed		
26	Whether registered with RXIL	To be confirmed (YES/NO)		

**NOTE:**

**1. Please indicate whether your firm is covered under MSEs/MSEs owned SC/ST or covered under SSI separately in Tech. Bid.**

**2. Terms & Conditions duly filled in and to be submitted along with offer otherwise your offer may not be evaluated.**

(BABLOO SONI)

DM/Purchase

Heavy Machine Building Plant/HEC

Dhurwa, Ranchi – 834004, Jharkhand (India).



एच॰ई॰सी॰

ISO 9001:2000

**HEAVY MACHINE BUILDING PLANT  
HEAVY ENGINEERING CORPORATION LIMITED**

(A Govt. of India Enterprise)

Ranchi – 834 004 (INDIA)

Annexure-C

Format of EMD Bank Guarantee

**BANK GUARANTEE FOR EARNEST MONEY DEPOSIT**

**NO.**

**Dated:**

**TO**

SDGM/PURCHASE /MM DIVISION  
HEAVY MACHINE BUILDING PLANT  
HEAVY ENGINEERING CORPORATION LTD.  
RANCHI-834004, JHARKHAND  
INDIA

Dear Sirs,

In consideration of your agreeing to accept the Earnest money deposit of Rs.-----  
(Rs.----- ) furnishable to you by M/s-----  
------(Hereinafter  
Referred to As Contractor) In terms of the Enquiry No. -----  
-----Dtd. ----- for Supply of ----- (Hereinafter  
Referred to as the Contract) in the form of a Bank Guarantee in the Manner hereinafter  
contained we -----, having registered office at ----  
-----do hereby covenant and agree with you as follows.

1. We hereby undertake to indemnify you up to a sum of Rs. ----- (Rs. -----  
----- only) against any loss or damage caused to or suffered by you  
or that may be caused to or suffered by you by reason of any breach or breaches on the  
part of the contractor of any of the terms and conditions contained in the said contract and  
in the event the Contractor shall make any default or defaults in carrying out any of the  
works under the said contract or otherwise in the observance and performance of any of  
the terms and conditions relating thereto in accordance with the true intent and meaning  
thereof, we shall forthwith on demand and without any protest or demur pay to you such  
sum or sums not exceeding in total the said sum of Rs.----- (Rs. -----  
*amount*-----only) as may be claimed by you as your losses and/or damages,  
costs, charges or expenses by reason of such default or defaults on the part of the  
contractor.

2. Notwithstanding anything to the contrary contained in this guarantee your decision as to  
whether the contractor has made any such default or defaults and the amount or amounts  
to which you are entitled by reasons thereof will be binding on us and we shall not be  
entitled to ask you to establish your claim or claims or damages or losses suffered by you  
but will pay the amount demanded by you under this guarantee forthwith on your demand  
without any protest or demur.



एच०ई०सी०

ISO 9001:2000

**HEAVY MACHINE BUILDING PLANT  
HEAVY ENGINEERING CORPORATION LIMITED**

(A Govt. of India Enterprise)

Ranchi – 834 004 (INDIA)

3. This guarantee shall continue and hold good until it is released by you on the application by the contractor after expiry of the related warranty period of the said contract and after the contractor have discharged all their obligations under the said contract and produced a certificate of due completion of the work under the said contract and submitted a "NO Demand Certificate" provided always that this guarantee shall in no event remain in force after the date of----- without prejudice to your claim or claims arisen and demanded from or otherwise notified to us in writing before the expiry of six months from the said date which will be enforceable against us not withstanding that the same is or are enforced after the said date.

4. We-----, further undertake to extend the validity of this beyond the period prescribed in clause 3 or as extended from time to time for such further period as may be required in writing before the Expiry of this and upon such extension(s), all terms and conditions of this shall remain in full force till the expiry of this extended period(s).

5. You will have the fullest liberty without affecting this guarantee from time to time to vary any of the terms and conditions of the said contract or extend the time of performance of the contractor or to postpone for any time or from time to time any of your rights or powers against the contractor and either to enforce or forbear to enforce any of the terms and conditions of the said contract and we shall not be released from our liability under this guarantee by the exercise of your liberty with reference to matters aforesaid or by reason of any time being given to the contractor or any other forbearance, act or omission on your part or any indulgence by you to the contractor or by any other variation or modification of the said contract or any other act, matter or things whatsoever, which, under the law relating to sureties, would but for the provisions hereof, have the effect of so releasing us from our liability hereunder provided always that nothing herein contained will enlarge our liability hereunder beyond the limit of Rs. ----- (Rs.----- -----) as aforesaid or extend the period of the guarantee beyond the said Date of ----- unless expressly agreed to by us in writing in terms of clause 4 hereof.

6. This guarantee shall not in any way be affected by your taking or varying or giving up any securities from the contractor or any other person, firm or company on its behalf or by the winding up, dissolution, insolvency or death as the case may be of the contractor.

7. In order to give full effect to the guarantee herein contained, you shall be entitled to act as if we are your principal debtors in respect of all your claims against the contractor hereby guaranteed by us as aforesaid and we hereby expressly waive all our rights of suretyship and other rights, if any, which are in any ways inconsistent with any of the provisions of this guarantee.

8. Subject to the maximum limit of our liability as aforesaid this guarantee will cover all your claim or claims against the contractor from time to time arising out of or in relation to the said contract and in respect of which your claim in writing is lodged on us before expiry of six months from the date of expiry of this guarantee.





एच॰ई॰सी॰

ISO 9001:2000

**HEAVY MACHINE BUILDING PLANT  
HEAVY ENGINEERING CORPORATION LIMITED**

(A Govt. of India Enterprise)

Ranchi – 834 004 (INDIA)

9. Any notice by way of demand or otherwise hereunder shall be in writing and may be sent by special Courier or Telefax to us or our Local Address as aforesaid.

10. This guarantee and the powers & provisions herein contained are in addition to and not by way of limitation or substitution for any other guarantee or guarantees heretofore given to you by us whether jointly with others or alone and now existing uncanceled and that this guarantee is not intended to and shall not revoke or limit such guarantee or guarantees.

11. This guarantee shall not be affected by any change in the constitution of the contractor or us nor shall it be affected by any change in your constitution or by any Amalgamation or absorption thereof or therewith but will ensure for the benefit or and be available to and enforceable by the absorbing or amalgamated company or concern.

12. This guarantee is irrevocable during the period of its currency and shall not be revoked without your previous consent in writing.

13. We further agree and undertake to pay you the amount demanded by you in writing irrespective of any dispute or controversy between you and the contractor or any reference to arbitration of the said dispute/controversy pending or a civil suit filed by the contract or in respect of the dispute or controversy.

14. Notwithstanding anything contained herein above our liability under this guarantee is restricted to Rs.----- (Rs. -----only) and this guarantee shall remain in force until -----unless a written claim is lodged on us for payment under this guarantee within six months from the date of expiry of this guarantee . i.e. On or before-----all your rights under this guarantee shall be forfeited and we shall be deemed to have released and discharged from all liabilities there under, irrespective of whether or not the original guarantee is returned to us.

15. We have power to issue this guarantee in your favour under the memorandum and articles of association of the bank and the undersigned has full power to execute this guarantee under the power of Attorney Granted to them by the Bank.

FOR AND ON BEHALF OF

-----



एच०ई०सी०

ISO 9001:2000

**HEAVY MACHINE BUILDING PLANT  
HEAVY ENGINEERING CORPORATION LIMITED**

(A Govt. of India Enterprise)

Ranchi – 834 004 (INDIA)

**Annexure-D**

**Format of BANK GUARANTEE of Security Deposit**

TO,  
M/S HEAVY ENGINEERING CORPORATION LIMITED  
PLANT PLAZA ROAD,  
DHURWA,  
RANCHI – 4

DEAR SIR,

IN CONSIDERATION OF YOUR AGREEING TO ACCEPT THE SECURITY DEPOSIT OF RS. ....'amount'..... FURNISHABLE TO YOU BY M/S ..... 'firms name'..... (HEREINAFTER REFERRED TO AS CONTRACTOR) IN TERMS OF THE CONTRACT NO. ....'HEC's purchase order no'.....FOR SUPPLY OF ..... 'details' of items'.....(HEREINAFTER REFERRED TO AS THE 'CONTRACT' ) IN THE FORM OF A BANK GUARANTEE IN THE MANNER HEREINAFTER CONTAINED WE.....'bank details'..... BRANCH, HAVING REGISTERED OFFICE AT ..... 'place'..... DO HEREBY COVENANT AND AGREE WITH YOU AS FOLLOWS:

1. WE HEREBY UNDERTAKE TO INDEMNIFY YOU UP TO A SUM OF RS. ....'amount'.....(RUPEES ..... 'amount in words'.....) AGAINST ANY LOSS OR DAMAGE CAUSED TO OR SUFFERED BY YOU OR THAT MAY CAUSED TO OR SUFFERED BY YOU BY REASON OF ANY BREACH OR BREACHES ON THE PART OF THE CONTRACTOR OF ANY OF THE TERMS AND CONDITIONS CONTAINED IN THE SAID CONTRACT AND IN THE EVENT THE CONTRACTOR SHALL MAKE ANY DEFAULT OR DEFAULTS IN CARRYING OUT ANY OF THE WORKS UNDER THE SAID CONTRACT OR OTHERWISE IN THE OBSERVANCE AND PERFORMANCE OF ANY OF THE TERMS AND CONDITIONS RELATING THERETO IN ACCORDANCE WITH THE TRUE INTENT AND MEANING THEREOF, WE SHALL FORTHWITH ON DEMAND AND WITHOUT ANY PROTEST OR DEMUR PAY TO YOU SUCH SUM OR SUMS NOT EXCEEDING IN TOTAL THE SAID SUM OF RS. ....'amount'.....(RUPEES ..... 'amount in words'.....) AS MAY BE CLAIMED BY YOU AS YOUR LOSSES AND / OR DAMAGES, COSTS, CHARGES OR EXPENSES BY REASON OF SUCH DEFAULT OR DEFAULTS ON THE PART OF THE CONTRACTOR.
2. NOTWITHSTANDING ANYTHING TO THE CONTRARY CONTAINED IN THIS GUARANTEE YOUR DECISION AS TO WHETHER THE CONTRACTOR HAS MADE ANY SUCH DEFAULT OR DEFAULTS AND THE AMOUNT OR AMOUNTS TO WHICH YOU ARE ENTITLED BY REASONS THEREOF WILL BE BINDING ON US AND WE SHALL NOT BE ENTITLED TO ASK YOU TO ESTABLISH YOUR CLAIM OR CLAIMS OR DAMAGES OR LOSSES SUFFERED BY YOU BUT WILL PAY THE AMOUNT DEMANDED BY YOU UNDER THIS GUARANTEE FORTHWITH ON YOUR DEMAND WITHOUT ANY PROTEST OR DEMUR.



एच॰ई॰सी॰

ISO 9001:2000

**HEAVY MACHINE BUILDING PLANT  
HEAVY ENGINEERING CORPORATION LIMITED**

(A Govt. of India Enterprise)

Ranchi – 834 004 (INDIA)

3. THIS GUARANTEE SHALL CONTINUE AND HOLD GOOD UNTILL IT IS RELEASED BY YOU ON THE APPLICATION BY THE CONTRACTOR AFTER EXPIRY OF THE RELATED WARRANTY PERIOD OF THE SAID CONTRACT AND AFTER THE CONTRACTOR HAVE DISCHARGED ALL THEIR OBLIGATIONS UNDER THE SAID CONTRACT AND PRODUCED A CERTIFICATE OF DUE COMPLETION OF THE WORK UNDER THE SAID CONTRACT AND SUBMITTED A 'NO DEMAND CERTIFICATE' PROVIDED ALWAYS THAT THIS GUARANTEE SHALL IN NO EVENT REMAIN IN FORCE AFTER THE DATE OF ...'date'..... WITHOUT PREJUDICE TO YOUR CLAIM OR CLAIMS ARISEN AND DEMANDED FROM OR OTHERWISE NOTIFIED TO US IN WRITING BEFORE THE EXPIRY OF SIX MONTHS FROM THE SAID DATE WHICH WILL BE ENFORCEABLE AGAINST US NOTWITHSTANDING THAT THE SAME IS OR ARE ENFORCED AFTER THE SAID DATE.
  
4. WE .....*'bank name'*....., FURTHER UNDERTAKE TO EXTEND THE VALIDITY OF THIS BEYOND THE PERIOD PRESCRIBED IN CLAUSE 3 OR AS EXTENDED FROM TIME TO TIME, FOR SUCH FURTHER PERIOD AS MAY BE REQUIRED IN WRITING BEFORE THE EXPIRY OF THIS AND UPON SUCH EXTENSION(S), ALL TERMS AND CONDITIONS OF THIS SHALL REMAIN IN FULL FORCE TILL THE EXPIRY OF THIS EXTENDED PERIOD(S).
  
5. YOU WILL HAVE THE FULLEST LIBERTY WITHOUT AFFECTING THIS GUARANTEE FROM TIME TO TIME TO VARY ANY OF THE TERMS AND CONDITIONS OF THE SAID CONTRACT OR EXTEND THE TIME OF PERFORMANCE OF THE CONTRACTOR OR TO POSTPONE FOR ANY TIME OR FROM TIME TO TIME ANY OF YOUR RIGHTS OR POWERS AGAINST THE CONTRACTOR AND EITHER TO ENFORCE OR FOREBEAR TO ENFORCE ANY OF THE TERMS AND CONDITIONS OF THE SAID CONTRACT AND WE SHALL NOT BE RELEASED FROM OUR LIABILITY UNDER THIS GUARANTEE BY THE EXERCISE OF YOUR LIBERTY WITH REFERENCE TO MATTERS AFORESAID OR BY REASON OF ANY TIME BEING GIVEN TO THE CONTRACTOR OR ANY OTHER FORBEARANCE , ACT OR OMISSION ON YOUR PART OR ANY INDULGENCE BY YOU TO THE CONTRACTOR OR BY ANY OTHER VARIATION OR MODIFICATION OF THE SAID CONTRACT OR ANY OTHER ACT, MATTER OR THINGS WHATSOEVER, WHICH, UNDER THE LAW RELATING TO SURETIES, WOULD BUT FOR THE PROVISIONS HEREOF, HAVE THE EFFECT OR SO RELEASING US FROM OUR LIABILITY HEREUNDER PROVIDED ALWAYS THAT NOTHING HEREIN CONTAINED WILL ENLARGE OUR LIABILITY HEREUNDER BEYOND THE LIMIT OF RS. ....*'amount'*.....(RUPEES .....*'amount in words'*.....) AS AFORESAID OR EXTEND THE PERIOD OF THE GUARANTEE BEYOND THE SAID DATE OF ...'date'.... UNLESS EXPRESSLY AGREED TO BY US IN WRITING IN TERMS OF CLAUSE 4 HEREOF.
  
6. THIS GUARANTEE SHALL NOT IN ANY WAY BE AFFECTED BY YOUR TAKING OR VARYING OR GIVING UP ANY SECURITIES FROM THE CONTRACTOR OR ANY OTHER PERSON, FIRM OR COMPANY ON ITS BEHALF OR BY THE WINDING UP, DISSOLUTION, INSOLVENCY OR DEATH AS THE CASE MAY BE OF THE CONTRACTOR.



एच०ई०सी०

ISO 9001:2000

**HEAVY MACHINE BUILDING PLANT  
HEAVY ENGINEERING CORPORATION LIMITED**

(A Govt. of India Enterprise)

Ranchi – 834 004 (INDIA)

7. IN ORDER TO GIVE FULL EFFECT TO THE GUARANTEE HEREIN CONTAINED, YOU SHALL BE ENTITLED TO ACT AS IF WE ARE YOUR PRINCIPAL DEBTORS IN RESPECT OF ALL YOUR CLAIMS AGAINST THE CONTRACTOR HEREBY GUARANTEED BY US AS AFORESAID AND WE HEREBY EXPRESSLY WAIVE ALL OUR RIGHTS OF SURETYSHIP AND OTHER RIGHTS, IF ANY, WHICH ARE IN ANY WAY INCONSISTENT WITH ANY OF THE PROVISIONS OF THIS GUARANTEE.
8. SUBJECT TO THE MAXIMUM LIMIT OF OUR LIABILITY AS AFORESAID THIS GUARANTEE WILL COVER ALL YOUR CLAIM OR CLAIMS AGAINST THE CONTRACTOR FROM TIME TO TIME ARISING OUT OF OR IN RELATION TO THE SAID CONTRACT AND IN RESPECT OF WHICH YOUR CLAIM IN WRITING IS LODGED ON US BEFORE EXPIRY OF SIX MONTHS FROM THE DATE OF EXPIRY OF THIS GUARANTEE.
9. ANY NOTICE BY WAY OF DEMAND OR OTHERWISE HEREUNDER SHALL BE IN WRITING AND MAY BE SENT BY SPECIAL COURIER, SPEED POST OR TELEFAX TO US AT OUR LOCAL ADDRESS AS AFORESAID.
10. THIS GUARANTEE AND THE POWERS & PROVISIONS HEREIN CONTAINED ARE IN ADDITION TO AND NOT BY WAY OF LIMITATION OF OR SUBSTITUTION FOR ANY OTHER GUARANTEE OR GUARANTEES HERETOFORE GIVEN TO YOU BY US WHETHER JOINTLY WITH OTHERS OR ALONE AND NOW EXISTING UNCANCELLED AND THAT THIS GUARANTEE IS NOT INTENDED TO AND SHALL NOT REVOKE OR LIMIT SUCH GUARANTEE OR GUARANTEES.
11. THIS GUARANTEE SHALL NOT BE AFFECTED BY ANY CHANGE IN THE CONSTITUTION OF THE CONTRACTOR OR US NOR SHALL IT BE AFFECTED BY ANY CHANGE IN YOUR CONSTITUTION OR BY ANY AMALGAMATION OR ABSORPTION THEREOF OR THEREWITH BUT WILL ENSURE FOR THE BENEFIT OF AND BE AVAILABLE TO AND ENFORCEABLE BY THE ABSORBING OR AMALGAMATED COMPANY OR CONCERN.
12. THIS GUARANTEE IS IRREVOCABLE DURING THE PERIOD OF ITS CURRENCY AND SHALL NOT BE REVOKED WITHOUT YOUR PREVIOUS CONSENT IN WRITING.
13. WE FURTHER AGREE AND UNDERTAKE TO PAY YOU THE AMOUNT DEMANDED BY YOU IN WRITING IRRESPECTIVE OF ANY DISPUTE OR CONTROVERSY BETWEEN YOU AND THE CONTRACTOR OR ANY REFERENCE TO ARBITRATION OF THE SAID DISPUTE / CONTROVERSY PENDING OR A CIVIL SUIT FILED BY THE CONTRACTOR IN RESPECT OF THE DISPUTE OR CONTROVERSY.
14. NOTWITHSTANDING ANYTHING CONTAINED HEREIN ABOVE OUR LIABILITY UNDER THIS GUARANTEE IS RESTRICTED TO RS. ....'amount'.....(RUPEES ..... 'amount in words'.....) AND THIS GUARANTEE SHALL REMAIN IN FORCE UNTILL ..... 'date'.... UNLESS A WRITTEN CLAIM IS LODGED ON US FOR PAYMENT UNDER THIS GUARANTEE WITHIN SIX MONTHS FROM THE DATE OF EXPIRY OF THIS GUARANTEE i.e. ON OR BEFORE ...'date' + '6 month'..... ALL YOUR RIGHTS UNDER THIS GUARANTEE SHALL BE FORFEITED AND WE SHALL



एच॰ई॰सी॰

ISO 9001:2000

**HEAVY MACHINE BUILDING PLANT  
HEAVY ENGINEERING CORPORATION LIMITED**

(A Govt. of India Enterprise)

Ranchi – 834 004 (INDIA)

BE DEEMED TO HAVE REALEASED AND DISCHARGED FROM ALL LIABILITIES THEREUNDER. IRRESPECTIVE OF WHETHER OR NOT THE ORIGINAL GUARANTEE IS RETURNED TO US.

15. WE HAVE POWER TO ISSUE THIS GUARANTEE IN YOUR FAVOUR UNDER THE MEMORANDUM AND ARTICLES OF ASSOCIATION OF THE BANK AND THE UNDERSIGNED HAS FULL POWER TO EXECUTE THIS GUARANTEE UNDER THE POWER OF ATTORNEY GRANTED TO THEM BY THE BANK.

FOR AND ON BEHALF OF  
*'name of bank'*

*'signature with seal'*



एच०ई०सी०

ISO 9001:2000

**HEAVY MACHINE BUILDING PLANT  
HEAVY ENGINEERING CORPORATION LIMITED**

(A Govt. of India Enterprise)  
Ranchi – 834 004 (INDIA)

**Annexure-E**

**FORMAT OF PERFORMANCE BANK GURANTEE**

(TO BE STAMPED IN ACCORDANCE WITH STAMP ACT & TO BE ISSUED BY ANY NATIONALISED /SCHEDULED BANK AUTHORISED BY RBI TO ISSUE A BANK GUARANTEE)

Name of Equipment: ----- Guarantee NO-----

Purchase Order No.:----- dated: ----- Date: -----

Validity -----

Claim period-----

To:

M/s Heavy Engineering Corporation Ltd.  
Heavy Machine Building Plant  
Ranchi-834004 Jharkhand

In consideration of your having placed an order bearing Purchase Order No.-----dated:-----  
- with-----  
------(hereinafter referred to as Supplier) for  
the supply of-----

----- (hereinafter referred to as the-----  
-----

We ----- do hereby agree with you irrevocably that, should the machinery and equipment fail to give the guarantee performance and achieve the efficiency as stipulated in the Purchase Order within the period of guarantee or should the material and/or workmanship of the machinery and equipment supplied or any part thereof be found defective and/or fully, as per the purchase order, we undertake to pay without any demur merely on demand a sum of Rs. -----  
being 20% of the value of Rs. -----for the supply of -----  
-----

Your decision whether the supplier have made any such defaults and the amount to which you are entitled by reasons thereof shall be conclusive and bind on us, subject to maximum of Rs. -----  
----- as aforesaid.

We-----further guarantee that the machinery and equipment manufactured and supplied by the supplier shall be new, of good quality materials and of the first class workmanship as specified in the Purchase order and should the machinery and equipment supplied or any part thereof be found defective and that should the defect as pointed out in inspection note be not made good and/or in case of failure within guarantee period same shall be replaced on free of cost or repaired on free of cost to the entire satisfaction of Heavy Engineering Corporation Ltd.

We -----agree that the guarantee herein contained shall remain in full force and effect till the machinery and equipment give the desired performance and it shall continue to be enforceable till your dues have been fully paid and claims satisfied or discharged subject to a period not later than-----. In the event of any extension granted for commissioning/dispatch suitable extension shall be given on your request.

We-----, further agree that any neglect, omission or forbearance or indulgence in enforcing any claim as per the terms and conditions of your purchase order or performance guarantee or any of them or any extension of the time granted for the performance or payment of penalty under the guarantee or any dispute between the supplier and yourselves as regard performance of machinery and equipment supplied or issued related to your Purchase



एच॰ई॰सी॰

ISO 9001:2000

**HEAVY MACHINE BUILDING PLANT  
HEAVY ENGINEERING CORPORATION LIMITED**

(A Govt. of India Enterprise)

Ranchi – 834 004 (INDIA)

order, shall not effect in any way our liability under this guarantee until the full payment, but in any case, shall not extend beyond-----.

This guarantee is in addition and not substitution for guarantee given to you by the seller or by their bankers on their behalf.

We----- lastly undertake not to revoke this bank guarantee during its currency except with the previous consent of the corporation in writing.

Notwithstanding anything to contrary stated above, our liability under this guarantee will be restricted to Rs. ----- and shall remain in force up to -----, unless a demand or claim under this guarantee is made from the date i.e. on or before-----  
-----all your rights under the said guarantee shall be forfeited and we shall be released and discharged from all liabilities there under.

Dated at ----- day of -----

Seal of the Bank





एच०ई०सी०

ISO 9001:2000

**HEAVY MACHINE BUILDING PLANT  
HEAVY ENGINEERING CORPORATION LIMITED**

(A Govt. of India Enterprise)

Ranchi – 834 004 (INDIA)

**Annexure F**

**Instructions for Online Bid Submission**

*The bidders are required to submit soft copies of their bids electronically on the CPP Portal, using valid Digital Signature Certificates. The instructions given below are meant to assist the bidders in registering on the CPP Portal, prepare their bids in accordance with the requirements and submitting their bids online on the CPP Portal.*

*More information useful for submitting online bids on the CPP Portal may be obtained at:  
<https://eprocure.gov.in/eprocure/app>.*

**REGISTRATION**

- (i) Bidders are required to enroll on the e-Procurement module of the Central Public Procurement Portal (URL: <https://etenders.gov.in/eprocure/app>) by clicking on the link "Online bidder Enrollment" on the CPP Portal which is free of charge.
- (ii) As part of the enrolment process, the bidders will be required to choose a unique username and assign a password for their accounts.
- (iii) Bidders are advised to register their valid email address and mobile numbers as part of the registration process. These would be used for any communication from the CPP Portal.
- (iv) Upon enrolment, the bidders will be required to register their valid Digital Signature Certificate (Class II or Class III Certificates with signing key usage) issued by any Certifying Authority recognized by CCA India (e.g. Sify / nCode / eMudhra etc.), with their profile.
- (v) Only one valid DSC should be registered by a bidder. Please note that the bidders are responsible to  
*ensure that they do not lend their DSC's to others which may lead to misuse.*
- (vi) Bidder then logs in to the site through the secured log-in by entering their user ID / password and the password of the DSC / e-Token.

**SEARCHING FOR TENDER DOCUMENTS**

- i) There are various search options built in the CPP Portal, to facilitate bidders to search active tenders by several parameters. These parameters could include Tender ID, Organization Name, Location, Date, Value, etc. There is also an option of advanced search for tenders, wherein the bidders may combine a number of search parameters such as Organization Name, Form of Contract, Location, Date, Other keywords etc. to search for a tender published on the CPP Portal.
- ii) Once the bidders have selected the tenders they are interested in, they may download the required documents / tender schedules. These tenders can be moved to the respective 'My Tenders' folder. This would enable the CPP Portal to intimate the bidders through SMS / e-mail in case there is any corrigendum issued to the tender document.
- iii) The bidder should make a note of the unique Tender ID assigned to each tender, in case they want to obtain any clarification / help from the Helpdesk.

**PREPARATION OF BIDS**

- i) Bidder should take into account any corrigendum published on the tender document before submitting their bids.
- ii) Please go through the tender advertisement and the tender document carefully to understand the documents required to be submitted as part of the bid. Please note the



एच०ई०सी०

ISO 9001:2000

**HEAVY MACHINE BUILDING PLANT  
HEAVY ENGINEERING CORPORATION LIMITED**

(A Govt. of India Enterprise)

Ranchi – 834 004 (INDIA)

number of covers in which the bid documents have to be submitted, the number of documents - including the names and content of *each of the document that need to be submitted. Any deviations from these may lead to rejection of the bid.*

- iii) Bidder, in advance, should get ready the bid documents to be submitted as indicated in the tender document / schedule and generally, they can be in PDF / XLS / RAR formats. Bid documents may be scanned with 100 dpi with black and white option which helps in reducing size of the scanned document.
- iv) To avoid the time and effort required in uploading the same set of standard documents which are required to be submitted as a part of every bid, a provision of uploading such standard documents (e.g. PAN card copy, annual reports, auditor certificates etc.) has been provided to the bidders. Bidders can use "My Space" or "Other Important Documents" area available to them to upload such documents. These documents may be directly submitted from the "My Space" area while submitting a bid, and need not be uploaded again and again. This will lead to a reduction in the time required for bid submission process.

**Note:** My Documents space is only a repository given to the Bidders to ease the uploading process. If Bidder has uploaded his Documents in My Documents space, this does not automatically ensure these Documents being part of Technical Bid.

#### **SUBMISSION OF BIDS**

- i) Bidder should log into the site well in advance for bid submission so that they can upload the bid in time i.e. on or before the bid submission time. Bidder will be responsible for any delay due to other issues.
- ii) The bidder has to digitally sign and upload the required bid documents one by one as indicated in the tender document.
- iii) Bidder has to select the payment option as "offline" to pay the tender fee / EMD as applicable and enter details of the instrument.
- iv) Bidder should prepare the EMD as per the instructions specified in the tender document. The original should be posted/couriered/given in person to the concerned official, latest by as specified in the tender documents. The details of the DD / any other accepted instrument, physically sent, should tally with the details available in the scanned copy and the data entered during bid submission time. Otherwise the uploaded bid will be rejected.
- v) Bidders are requested to note that they should necessarily submit their financial bids in the format provided and no other format is acceptable. If the price bid has been given as a standard BOQ format with the tender document, then the same is to be downloaded and to be filled by all the bidders. Bidders are required to download the BOQ file, open it and complete the white coloured (unprotected) cells with their respective financial quotes and other details (such as name of the bidder). No other cells should be changed. Once the details have been completed, the bidder should save it and submit it online, without changing the filename. If the BOQ file is found to be modified by the bidder, the bid will be rejected.
- vi) The server time (which is displayed on the bidders' dashboard) will be considered as the standard time for referencing the deadlines for submission of the bids by the bidders, opening of bids etc. The bidders should follow this time during bid submission.



एच॰ई॰सी॰

ISO 9001:2000

**HEAVY MACHINE BUILDING PLANT  
HEAVY ENGINEERING CORPORATION LIMITED**

(A Govt. of India Enterprise)

Ranchi – 834 004 (INDIA)

- vii) All the documents being submitted by the bidders would be encrypted using PKI encryption techniques to ensure the secrecy of the data. The data entered cannot be viewed by unauthorized persons until the time of bid opening. The confidentiality of the bids is maintained using the secured Socket Layer 128 bit encryption technology. Data storage encryption of sensitive fields is done. Any bid document that is uploaded to the server is subjected to symmetric encryption using a system generated symmetric key. Further this key is subjected to asymmetric encryption using buyers/bid openers public keys. Overall, the uploaded tender documents become readable only after the tender opening by the authorized bid openers.
- viii) The uploaded tender documents become readable only after the tender opening by the authorized bid openers.
- ix) Upon the successful and timely submission of bids (i.e. after Clicking “Freeze Bid Submission” in the portal), the portal will give a successful bid submission message & a bid summary will be displayed with the bid no. and the date & time of submission of the bid with all other relevant details.
- x) The bid summary has to be printed and kept as an acknowledgement of the submission of the bid. This acknowledgement may be used as an entry pass for any bid opening meetings.

**ASSISTANCE TO BIDDERS**

- i) Any queries relating to the tender document and the terms and conditions contained therein should be addressed to the Tender Inviting Authority for a tender or the relevant contact person indicated in the tender.
- ii) Any queries relating to the process of online bid submission or queries relating to CPP Portal in general may be directed to the 24x7 **CPP Portal** Helpdesk.

Note: For any query related to registration and processing on the Portal please visit FAQ available at

<https://etenders.gov.in/eprocure/app?page=FAQFrontEnd&service=page>

You may call the Helpdesk. The 24 x 7 Help Desk Numbers are

0120-4200462, 0120-4001002, 0120-4001005, 0120-6277787

E-Mail: [support-eproc@nic.in](mailto:support-eproc@nic.in)

**Or**

You may call to our service provider, Mr. Kushal (7903884318)

E-Mail: [kushalnicccl@gmail.com](mailto:kushalnicccl@gmail.com)



एच॰ई॰सी॰

ISO 9001:2000

**HEAVY MACHINE BUILDING PLANT  
HEAVY ENGINEERING CORPORATION LIMITED**

(A Govt. of India Enterprise)

Ranchi – 834 004 (INDIA)

Annexure-G

**(Technical Specification)**

Work Order No.	Crane Capacity	Qty.
2018.558.100	50/12.5T x 20.1 M	1

**01. INTENT OF SPECIFICATION**

- 01.01 This tender specification calls for turnkey execution of the job covering the design, engineering, manufacture, handling (loading and unloading), supply FOR HMBP stores at Ranchi, transportation from purchaser's store at FFP, HEC site to crane erection site, erection, testing, commissioning of electrics with standard accessories and attachment as covered in this specification as well as enclosed GA diagram Nos. **3339.20.000** and demonstration of performance guarantee parameters of the equipment / system in a coordinated and integrated manner as per the relevant clauses of the specification. The crane parameters are specified at Annexure – I.

The following are the lists of cranes for Steel Melting Shop (02 shop) of FFP, HEC, Ranchi.

Sl. No.	Description	Qty	Location	Remarks
<b>EOT Cranes in 02 Shop (SMS)</b>				
1.	50/12.5T x 20.1 M	1	02 SHOP, FFP	

- 01.02 The Contract Technical Specification shall be read in conjunction with relevant IS and IPSS. The provisions given in these documents shall be mutually supplementary and complimentary to one another. However, in case of any conflict between the provisions of these documents with respect to technical matter, the provisions in the contract technical specification will prevail.

In case of any discrepancy between this contract technical specification and standard mentioned above, this contract technical specification shall prevail upon the standard. In case of discrepancy between IPSS and IS / International codes, IPSS shall prevail.



एच०ई०सी०

ISO 9001:2000

**HEAVY MACHINE BUILDING PLANT  
HEAVY ENGINEERING CORPORATION LIMITED**

(A Govt. of India Enterprise)

Ranchi – 834 004 (INDIA)

This specification is a guideline only and the design & engineering shall be complete in all respect and any equipment or facility not covered in this specification but considered essential for proper installation, operation and maintenance of electrics for EOT cranes shall be deemed to be included in the scope of work of the tenderer.

**02.00 SCOPE OF WORK & SUPPLY**

02.01 The scope of work of the tenderer shall consist turnkey execution of the job of design, engineering, manufacture, inspection, assembly, shop testing, painting at manufacturer's shop as well as at site after erection, handling (loading and unloading) supply FOR HMBP stores at Ranchi, transportation from purchaser's store at FFP, HEC site to crane erection site, receipt, unloading, erection, testing & commissioning of Electrics for Double Girder EOT crane at FFP, HEC Ranchi, Jharkhand as per technical parameters indicated in the technical specification & the GA drg.

The scope of supply covers all electrical equipment commencing from main current collectors on the crane and all other electrical items beyond the main current collectors of the crane i.e. DSL main current collectors, power disconnecting switch on bridge platform after main current collectors, protective and control switch gear, VFD & AFE panel, motors, control and all power and control cables including supports, socket outlets, lighting distribution panel and lighting fixtures with lamps, festoon cable system for crane trolley, master controllers, indicating lamps, push buttons, earthing materials etc. A broad list of items is furnished at **cl 02.02.16**. However, any other item though not specifically mentioned but required for proper operation of the system shall deemed to be included in the scope of the tenderer.

1 (one) no. of laptop with licensed version of all software is included in the scope of supply. Licensed version of all the required software, hardware/accessories i.e. cables, connectors etc for parameterization of drives are included with the crane electrics.

The scope of supply shall also include supply of all commissioning spares with minimum quantities as indicated in clause no **03.01** of this T.S.

All sundry erection materials including mounting channels cable trays required for installation and connecting up of electrical equipment with cable laying and fixing accessories shall be included in the scope of supply by tenderer.

02.02 Supply of electrics for cranes shall consist of the following:

02.02.01 Supply of all electrical components and standard accessories required for proper functioning of the crane.

02.02.02 Supply of VFDs for 415V system for all mechanisms for the cranes (as specified in TS).

02.02.03 Supply of 100% redundant AFE convertors with common DC bus configuration along with associated DC Isolators of proper rating.

02.02.04 Supply of suitably sized Jn. Box on Crane girder & main trolley for termination of festoon Cables (as required).

02.02.05 Supply of erection, wiring and earthing material.

02.02.06 The scope of supply shall cover all items including the danger boards, rubber mat, consumables necessary for erection, testing and commissioning of the Electrics for cranes.

02.02.07 The scope of supply shall cover one set of engineer's tool box with



एच०ई०सी०

ISO 9001:2000

**HEAVY MACHINE BUILDING PLANT  
HEAVY ENGINEERING CORPORATION LIMITED**

(A Govt. of India Enterprise)

Ranchi – 834 004 (INDIA)

insulated tools.

- 02.02.08 Supply of commissioning spares as per clause no. 03.01.
- 02.02.09 The scope of supply shall cover supply of required quantity of paints for retouching at site, if required.
- 02.02.10 Supply of drawings and documents as per Clause 07.02 & 07.03.
- 02.02.11 Training for engineers of FFP, HEC for VFD's. Tenderer to impart 15 mandays training at site and 15 mandays at VFD manufacturer's training center.**
- 02.02.12 Supply of accessories as indicated in the TS.
- 02.02.14 Construction power supply board including supply of cables, tapping power from purchaser's distribution board, maintaining the board & the cables will be in the scope of supply of tenderer.
- 02.02.15 The following items are free issue items by the purchaser
- DC Electromagnetic brakes with brake rectifier panels
  - Limit switches
- Responsibility matrix defining the scope of work for the above free issue items is enclosed at 02.02.17.
- 02.02.16 Scope of supply shall cover, but not be limited to, the following items.  
Any item though specifically not mentioned but required for proper functioning and completeness of the system shall be deemed to be included in scope of tenderer.

**50/12.5 T x 20.1M - Qty: 1 no.****ITEM CODE: 5533313632**

SI No.	Description	Qty per crane	Total qty for 1 crane	Remarks
1.	Lighting transformer 415/240V, 1Ph, 50Hz, 7.5KVA.	1	1	
2.	Protective panel	1set	1 set	
3.	Gravity type current collector, rated 500A,1.1KV, 8 nos per crane	1 set	1 set	
4.	Isolator panel	1 set	1 set	
5.	Active front end converters	2 sets	2 sets	Please refer VFD, AFE list as per
6.	Inverter for Main Hoist	1 set	1 set	



एच०ई०सी०

ISO 9001:2000

**HEAVY MACHINE BUILDING PLANT  
HEAVY ENGINEERING CORPORATION LIMITED**

(A Govt. of India Enterprise)

Ranchi – 834 004 (INDIA)

7.	Inverter for Aux. Hoist	1 set	1 set	clause - 02.02.19
8.	Inverter for Cross Travel	1 set	1 set	
9.	Inverter for Long Travel	1 set	1 set	
10.	Arm chair control unit including master controller	1	1	
11.	Hollow shaft Pulse encoder with Torque arm	4	4	
12.	Lighting distribution panel	1	1	
13.	Laptop computer	1 set	1 set	
14.	UPS with battery back up	1set	1set	
15.	Emergency corner switch	4	4	
16.	Terminal box on bridge and main trolley (TBBM/TBTM)	2	2	
17.	Junction box with 10 nos. of CATM4 terminal	8	8	
18.	Junction box with 6 nos. of CATM4 terminal	16	16	
19.	Cables for fixed wiring	1 lot	1 lot	
20.	L.T flexible festoon cable for CT	1 lot	1 lot	
21.	Lighting fittings & cabin fan	1 set	1 set	
22.	Drive motors	1 lot	1 lot	Please refer motor list as per clause - 02.02.18
23.	Fire extinguisher, CO <sub>2</sub> type, 3.5 kg	5 nos	5 nos	
24.	Commissioning spares	1 set	1 set	Pl. refer Cl. 03.01
25.	Erection accessories including channels fasteners lugs, glands, rubber mats, slotted angles, cable ties, cable trays earthing material etc.	1 lot	1 lot	
26.	Installation of electrical items, cable laying, termination & commissioning	1 lot	1 lot	





एच.ई.सी.

ISO 9001:2000

**HEAVY MACHINE BUILDING PLANT  
HEAVY ENGINEERING CORPORATION LIMITED**

(A Govt. of India Enterprise)

Ranchi – 834 004 (INDIA)

27.	Engineer's tool box with insulated tools	-	1 set	
28.	Erection of all electrical equipments	-	-	
29.	Testing and commissioning of the complete electrical system.	-	-	Please refer responsibility matrix as per clause - 02.02.17

**02.02.17 Responsibility Matrix for free issue items :**

Sl. No.	Equipment	Equipment supply	Cable Supply	Installation	Commissioning
1.	<b>DC EM Brake</b>				
	a. Brake	HEC	Tenderer	HEC	Tenderer
	b. Brake Rectifier Panel	HEC	Tenderer	Tenderer	Tenderer
2.	<b>Limit Switch</b>	HEC	Tenderer	Tenderer	Tenderer

**02.02.18 MOTOR LIST**

The mechanical KW; selected frame KW at 50°C & S1 duty; frame size and other details of the motors are as indicated in the table given below. However, the frame KW and the current values need to be checked by the tenderer and confirmed. It may pl. be noted that selection of frame KW and confirmation of these values on the basis of the mechanical KW furnished by us shall be the responsibility of the tenderer and they will have to guarantee the performance of the offered system.

Details of squirrel cage motors for all the mechanisms

Sl. No.	1	2	3	4
Mech.	Main Hoist	Aux. Hoist	CT	LT
Frame size	315M	280M	160M	280S
RPM (Syn.)	750	750	1000	1000



एच०ई०सी०

ISO 9001:2000

**HEAVY MACHINE BUILDING PLANT  
HEAVY ENGINEERING CORPORATION LIMITED**

(A Govt. of India Enterprise)

Ranchi – 834 004 (INDIA)

<b>Duty</b>	S4, 40%	S4, 40%	S4 , 40%	S4 , 40%
<b>St / hour</b>	150	150	150	150
<b>Mech. KW</b>	44.9	34.54	3.67	23.01
<b>Frame KW at 50°C, S1 Duty</b>	75	45	7.5	45
<b>Motor current at mechanical KW</b>	99A	70A	11A	53A
<b>Shaft extension</b>	Cylindrical / Double tapered	Cylindrical / Double tapered	Cylindrical / Double tapered	Cylindrical / Double tapered
<b>Location of terminal box</b>	On top	On top	On top	On top
<b>Qty of motor per crane</b>	1	1	1	2
<b>Total qty for 1 crane</b>	1	1	1	2

**02.02.19 Minimum current ratings at 50°C for AFE & VFDs are given below**

Sl. No.	Mechanism	VFD		AFE		Remarks
		Minimum current ratings at 50°C Amperes	Qty / crane (Sets)	Minimum current ratings at 50°C Amperes	Qty / crane (Sets)	
1.	Main Hoist	149 A	1	*(See note-4)	1 + 1	
2.	Aux. Hoist	105A	1		=	
3.	CT	17 A	1		2 sets	
4.	LT	159A	1			

However, selection of the ratings of the VFD's & AFE's on the basis of the motor current at mechanical KW and the technical requirements will be the responsibility of the tenderer. No extra cost will be admissible on account of any increase in size due to the actual motor currents being higher.

NOTE: - 1. **Motor current values are tentative and shall be checked and confirmed by the bidder.**



एच॰ई॰सी॰

ISO 9001:2000

**HEAVY MACHINE BUILDING PLANT  
HEAVY ENGINEERING CORPORATION LIMITED**

(A Govt. of India Enterprise)

Ranchi – 834 004 (INDIA)

2. **Selection of VFD's & AFE's as per the motor current at mechanical KW & the TS shall be the responsibility of the tenderer. No extra cost will be admissible for any increase in these values.**
3. **Current Rating of VFD at 50°C shall be minimum 150% of the motor current at mechanical KW. All the VFDS shall be derated at 50°C.**
4. **Current rating of the AFE at 50°C is sum of current rating of selected inverters at 50°C for two largest mechanisms (main hoist and long travel).**
5. **All the VFD/ AFE shall be heavy duty type i.e. suitable for 150% of rated current for 1 minute followed by 100% load in a duty cycle of 5 minutes.**

**03.00 Spares****03.01 Commissioning Spares**

The Contractor shall provide with each crane minimum commissioning spares as listed below required for proper erection and commissioning of the equipment until final acceptance following demonstration of performance guarantee.

However, any additional spares required for successful commissioning of equipment shall be supplied by contractor free of cost.

**List of commissioning spares**

Sl.No.	Item	Quantity	Remarks
1.	Indicating lamp with holder	1 no. for each type	-
2.	Power contactor	1 no. for each type	-
	a) Contactor contacts	1 set. for each type	-
	b) Coil	1 no. for each type	-
3.	Auxiliary contactor	1 no. for each type	-
	a) Contactor contacts	1 set. for each type	-
	b) Coil	1 no. for each type	-
4.	Push button	1 no. for each type	-



एच०ई०सी०

ISO 9001:2000

**HEAVY MACHINE BUILDING PLANT  
HEAVY ENGINEERING CORPORATION LIMITED**

(A Govt. of India Enterprise)

Ranchi – 834 004 (INDIA)

5.	Power fuses	5% of each rating	-
6.	Control fuses	10% of each total quantity	-
7.	Control switches	1 no.	-
8.	Semiconductor fuses	2 no.	-
9.	IGBT	5% of each type	-
10.	Plug in cards	10 no. of each type	-

**03.02 Essential Spares: -**

List of 2 years operations spares item wise with model number, manufacturer's catalogue number, part number, quantities, OEM's Contact address such as Phone, Fax numbers and E-mail address, per unit rates shall be submitted at the end of 8<sup>th</sup> month from the date of signing of the contract. Order for these items shall be placed by purchaser separately as required.

**List of essential spares for two years of operation**

Sl. No.	Item	Qty.	% of total equipment
1	Controls		
	Power contactors	1 no. of each rating.	
a)	Coils for aux. contactors	Min. 1 no. for each type	25%
b)	Over load relay	Min. 1 no. for each type	100%
c)	Timers	Min. 2 nos.	15%
d)	Aux. Contactors	Min. 1 no. of each type	25%
2.	Master controller: Moving contacts & fixed	25% each type	25%



	contacts		
3.	Fuses		
	a) Power circuit fuses	Min. 1 no. of each rating	100%
	b) Power circuit base (fuse)	Min. 1 no. of each type	25%
	c) Control circuit fuse	Min. 4 nos.	100%
	d) Control circuit base	Min. 1 no.	25%
5.	Indicating lamp with holder	Min. 2 nos.	25%
6.	Push buttons	Min. 1 set	40%
7.	IGBT module of each type		5%
8.	Semiconductor fuses	2 nos.	
9.	Plug –in cards	10 nos. of each type	

**04.00 INSTRUCTIONS TO TENDERER**

04.01 This specification shall be read in conjunction with Indian standards and IPSS.

04.02 This specification covers design, engineering, manufacture, fabrication, assembly, shop testing, painting, supply, handling (loading and unloading) of materials and transportation from purchaser's store at FFP/ HEC site to crane erection site, erection, testing and commissioning of electrics for Double Girders EOT cranes complete with all accessories & attachments as per this specification and enclosed crane GA drawings and demonstration of performance guarantee parameter of the equipment/system in a coordinated and integrated manner as per the relevant clauses of the specification.



एच॰ई॰सी॰

ISO 9001:2000

**HEAVY MACHINE BUILDING PLANT  
HEAVY ENGINEERING CORPORATION LIMITED**

(A Govt. of India Enterprise)

Ranchi – 834 004 (INDIA)

- 04.03 Tenders shall be accompanied with the information as required in cl 07.01. Tenders may be rejected if all information's required are not furnished while tendering. The tenderer shall clearly specify any request for deviation from technical specifications in the format enclosed at Annexure II. Deviation indicated elsewhere other than the enclosed format will not be considered.
- 04.04 The Tenderer shall submit a time bar chart along with the tender indicating starting and completion dates showing breakup of time required for various activities along with schedule of erection, testing and commissioning of the Electrics for the cranes.
- 04.05 Drawings as per cl. No. 07.02 shall be submitted in 6 sets for each crane to the Purchaser in stages for approval / reference within one month of issue of Letter of Intent and prior to commencement of manufacturing. The Purchaser shall send his comments within 15 days of receipt of the drawings. However, approval of drawings by the Purchaser will not relieve the supplier of his responsibilities for correctness, adequacy of the design and completeness of his work as per the contract. Approval of drgs. from FFP shall be the responsibility of tenderer. Any minor change during approval stage shall be the responsibility of the tenderer and same shall be incorporated without any price implication.
- All the drgs. and documents will be in English Language. Drawings shall be complete in all respect with dimensions, item lists, weights, sub-supplier's name etc.
- 04.06 The supplier shall furnish 6 sets of prints of all approved drawings per crane as per Cl. No. 07.03.
- 04.07 If the drawings and other particulars are returned, because they are incomplete or incorrect, the Supplier shall not be given any extension of time on this account.
- 04.08 The supplier shall furnish adequate nos. of prints of all erection drawings as showing the mark numbers with weights of the various items to be assembled at site.
- 04.09 The documents supplied prior to commissioning of the crane.



एच०ई०सी०

ISO 9001:2000

**HEAVY MACHINE BUILDING PLANT  
HEAVY ENGINEERING CORPORATION LIMITED**

(A Govt. of India Enterprise)

Ranchi – 834 004 (INDIA)

- 04.10 The following documents shall be supplied prior to commissioning of the crane.
- iii) Soft copy with hard copy of all drawing and data which have been approved by the purchaser.
- iv) Soft copy along with hard copy of erection, testing, commissioning and operating manuals, electrical circuit diagrams, catalogues of all electrical equipments, technical specification, catalogues and technical manuals of all bought out items etc and information on special features.
- 04.11 The no load test of Crane Bridge and trolley shall be carried out separately at site in presence of purchaser's representative; over load and rated load test of the cranes and hoists shall also be carried out at site.
- 04.12 Construction power shall be provided free of cost at one point within the shop (within 300m) tenderer shall lay necessary cables up to erection site for their requirement.
- 04.13 The supplier shall submit test certificates for all electrical equipments & cables.
- 04.14 The following test shall be carried out at manufacturer's premises during inspection.
- High voltage test of panels.
  - Integrated panel testing
  - Routine test for all motors shall be carried out at motor manufacturer's premises.
- 04.15 All the electrical equipment shall be of reputed make and proven quality with regard to their performance. The make shall be as per approved list of FFP. However, makes of items not included in the preferred make list shall be subjected to approval by FFP. Makes of major components like VFD & motors being considered by the tenderer shall be furnished with the offer.
- 04.16 The equipments shall be offered for inspection and testing during different stages of its manufacture, starting from raw materials till completion by the purchaser / his authorized representative at the Supplier's or his sub-supplier's works as per the inspection procedure mutually agreed.





एच०ई०सी०

ISO 9001:2000

**HEAVY MACHINE BUILDING PLANT  
HEAVY ENGINEERING CORPORATION LIMITED**

(A Govt. of India Enterprise)

Ranchi – 834 004 (INDIA)

Inspection shall be regarded as a check up and shall be in no way binding on the purchaser.

04.17 Documents for all electrical equipment supplied with the crane shall be put up for inspection along with the equipment.

After inspection, an endorsement would be made in the inspection certificate about the availability of the documents.

04.18 Ability and Experience of the Tenderer

i) The Tenderer shall satisfy the Purchaser that he possesses necessary technical know-how and facilities to execute the order. Necessary particulars to establish the same shall be furnished along with the tender.

ii) Reference list of similar job executed elsewhere during last five years (client's address, purchase order no., date of placement of order, schedule delivery period vs actual delivery period, annual audited report for last 5 years with literature/ catalogues of previous supply.

iii) A write-up on testing facilities available in the manufacturer's works shall be furnished by the Tenderer.

04.19 Necessary clearance from statutory authorities (if any) shall be obtained before the cranes are put under operation immediately after the cranes are commissioned. The crane after erection shall be tested as follows:

i) Insulation tests and other tests mentioned shall be carried out as per the latest IS: 3177 & IS: 4137 (as applicable).

ii) Speed Tests

a) All motion of the crane shall be tested with rated load on all notches at the time of commissioning of the crane at site and the speeds shall be attained within the tolerance limit.

b) All motions of the crane shall be tested with 25% over load in which case the specified speeds need not be attained but the crane shall show itself capable of dealing with the over load without difficulty.

**05.00 TECHNICAL SPECIFICATION FOR ELECTRICS OF THE CRANES**

**05.01** Electrics for the EOT cranes shall be designed, manufactured, assembled



एच०ई०सी०

ISO 9001:2000

**HEAVY MACHINE BUILDING PLANT  
HEAVY ENGINEERING CORPORATION LIMITED**

(A Govt. of India Enterprise)

Ranchi – 834 004 (INDIA)

tested, erected and commissioned in accordance with the latest edition of IS: 807, 3177 and 4137 or and all other relevant National /International codes and relevant IPSS as applicable and also details indicated in this specification.

In case any discrepancy between this technical specification and standard mentioned above, this technical specification shall prevail upon the standard. In case of discrepancy between IPSS and IS/International codes, IPSS shall prevail.

**05.02.01 Standards:**

The design, manufacture, assembly and testing as well as performance of the equipment shall conform to the IPSS in respect of items for which IPSS have been issued; otherwise, to the relevant IS specifications (latest revision).

In case the tenderer is not in a position to comply fully with certain IPSS / BIS specifications, or in respect of certain items for which there are no IPSS / BIS specifications, the tenderer shall base his proposals on IEC recommendations or other reputed national and international standards subject to the approval of the purchaser.

All equipment supplied and all work done including system design and detailed engineering shall also comply with the statutory requirements of the Government of India and the Government of Jharkhand and with the Indian Electricity Rules.

**05.02.02 Climatic conditions:**

Motors, VFD panels and all others components shall be suitable for ambient temperature of 50°C.

The equipment offered shall be suitable for smooth, efficient and trouble free service in the tropical humid climate prevailing at Ranchi and under the ambient temperature conditions indicated above. Wherever required the equipment shall be adequately protected against damage from radiant heat and hot air.

The equipment shall be designed to give efficient and reliable performance and shall be such that the risks of accidental short- circuits due to animals, birds or vermin's are obviated.

**05.02.03 Power supply and standard voltage levels:**

The following standardized voltage levels shall be adopted:



एच॰ई॰सी॰

ISO 9001:2000

**HEAVY MACHINE BUILDING PLANT  
HEAVY ENGINEERING CORPORATION LIMITED**

(A Govt. of India Enterprise)

Ranchi – 834 004 (INDIA)

a)	LTAC	:	415 V $\pm$ 10%, 3-phase, 4-wire, 50 Hz $\pm$ 5%. The 4 <sup>th</sup> wire being the solidly earthed.
b)	AC control and signaling voltage	:	240 V AC, $\pm$ 10% obtained using suitable control transformer.
c)	Socket outlets for		
	Hand lamps	:	240 V, single phase, 50 Hz, AC obtained through suitable transformers
	Hand tools	:	240 V, 15A, 2 pin plus earth with plug interlocked switch
d)	Electro-magnetic brakes	:	220 V, DC obtained through individual brake control panels.
e)	Illumination/ lighting	:	240 V, AC
The three phase symmetrical short-circuit ratings of the switch gear at 415 V shall be 50 kA for 1 second. The system/ unit/ equipment shall be designed so as to be suitable for the following variations in voltage and frequency :			
		Voltage	Frequency
	Permissible variations with rated performance, rated current and control effectiveness maintained	$\pm$ 10%	$\pm$ 5%
		For LT system	
	Permissible variations for control and regulation equipment with rated performance and control quality maintained	$\pm$ 10%	+3% & - 5%

Voltage dip on the starting of largest LT motor shall be limited to 15% of the nominal voltage at the motor terminals.

Total voltage dip on starting of large motors on crane shall be limited to 3% on crane and 6% in DSL system.

**05.02.04 Power distribution on crane:**

One adequately rated load break manual isolator with locking facility shall



एच॰ई॰सी॰

ISO 9001:2000

**HEAVY MACHINE BUILDING PLANT  
HEAVY ENGINEERING CORPORATION LIMITED**

(A Govt. of India Enterprise)

Ranchi – 834 004 (INDIA)

be provided immediately after current collectors on incoming line on the crane. The isolator shall be capable of carrying current of two largest mechanisms.

Power from the isolator shall be taken to the MCCB. Tripping device for the MCCB to be provided in operator's cabin.

The breaker shall be provided with under voltage, over load and short circuit releases. The breaker shall also be with earth fault protection. The breaker can be closed only when:

- All master controller handles are in neutral position.
- None of the stator or directional contactors are in closed positions
- Emergency corner switches not operated.
- Door/Gate switch are not actuated and gravity limit switch for hoist motion not operated.

The drawing of single line diagram of cranes is listed below:

Sl. No.	Crane capacity	Drawing No.
1	50/12.5 T x 20.1 M	3339.094.001

Power for lighting circuit shall be tapped from the incoming side of isolators near current collector.

**05.02.05 Power supply for CT motion:**

Flexible trailing cable systems mounted on retracting support system shall be used. The system shall consist of insulated multi-conductor or several single conductor cables with permanent termination on the bridge and on the trolley. The flexible trailing cables shall have ample length and shall be supported by means of properly designed movable clamps. These clamps shall be fitted with rollers and shall run freely on a guide rail allowing relative movement of bridge and trolley without undue stress or wear on the suspended cable. Provision shall be made for inclusion of spare cable at a later stage in case of necessity. The flexible cable shall be EPR insulated CSP sheathed type.

The cable car / moveable cable clamp and posts are not included in the tenderer's scope and shall be supplied and installed by the purchaser. Laying of cables on the same shall be included in the scope of the tenderer.



एच॰ई॰सी॰

ISO 9001:2000

**HEAVY MACHINE BUILDING PLANT  
HEAVY ENGINEERING CORPORATION LIMITED**

(A Govt. of India Enterprise)

Ranchi – 834 004 (INDIA)

**05.02.06 Meters:**

Ammeter and voltmeter with selector switches shall be provided on the incoming line in protective panel.

**05.02.07 Control features:**

All the motions shall be provided with VFD control using Squirrel Cage Induction Motor. However all controls shall be operated through master controllers.

For long travel drives, the electrical control shall be grouped for the individual pair of motors separately in case of four motor drive and each pair of motors shall be able to drive the crane at reduced acceleration and speed.

As an anti-skewing measure, out of a pair of motors for LT., if one drive motor trips, the other drive motor shall also be switched off.

Brakes shall not be used for speed control.

Closed loop regulation suitable for the system with various feedback such as speed, current etc. shall be provided.

Speed feedback shall be provided for each motor through pulse tacho mounted on the non driving end of the motor shaft. All the pulse tacho output shall be directly hardwired to the respective VFD terminals directly.

The regulation shall include ramp generators, potentiometers for various setting, various regulators, signal conditioners, logic command module sequence, module, trigger module, zero and over speed monitor, torque less protection module etc. as per the requirements. The control and regulation equipment shall be able to maintain their rated performance and control quality even under conditions of variation of +/-10% in voltage and  $\pm 5\%$  in frequency. A zero current sensing device shall be incorporated. The reversing of motor direction shall be done at zero current. Braking down to zero speed shall be electrical with mechanical brake setting only at zero speed. Protective features like anti-drop etc. shall be incorporated to prevent load sinking. The circuitry shall also provide for the protection against failure of motor torque such that the mechanical brake sets in such



एच॰ई॰सी॰

ISO 9001:2000

**HEAVY MACHINE BUILDING PLANT  
HEAVY ENGINEERING CORPORATION LIMITED**

(A Govt. of India Enterprise)

Ranchi – 834 004 (INDIA)

cases. All other features of conventional crane controls shall also be built into the scheme. The following shall also be provided on the A.C. side.

- Surge suppressor
- Over current protection
- Overload protection
- Under voltage protection
- Single phase protection
- Phase sequence protection
- Ammeter and voltmeter with selector switches
- Isolating switches

Control and auxiliary supply shall be provided with separate transformer and under voltage protection.

**05.02.08 VFD control drives**

VFD control shall be provided for all the mechanism of all the cranes. Control shall be achieved through master controllers for each direction. Rated and creep speeds are to be provided in each mechanism. Creep speed shall be 10% or lower as per operational requirements of rated speed.

The VFD shall be fully controlled and suitable for four quadrant operation (active front end type). Other details of VFD shall be as per respective clause for VFD in the IS and IPSS.

The cables for the VFD and associated equipment shall be laid and clamped separately on the crane.

The current rating of AFE shall be selected on the basis of summation of current rating of selected inverters at 50°C for two largest mechanisms of the crane.

Current Rating of the VFD at 50°C shall be minimum 150% of the motor current at mechanical KW.

All the VFD's are to be derated at 50°C.

For all cranes, vector control drives having redundant common AFE and individual inverter for motors of all motions shall be provided.



एच॰ई॰सी॰

ISO 9001:2000

**HEAVY MACHINE BUILDING PLANT  
HEAVY ENGINEERING CORPORATION LIMITED**

(A Govt. of India Enterprise)

Ranchi – 834 004 (INDIA)

The common DC bus shall have 02 incomers and no bus coupler. All the incomers shall be double pole DC switch dis-connector. The double pole DC switch dis-connector shall be suitable for minimum 1000 V DC.

Isolators between common DC bus and individual inverters shall be provided.

To take care of the under voltage in the incoming power supply system of the crane for more than the set time in under voltage relay due to the motor regeneration and motoring mode, a UPS of proper rating with 30 minute backup shall be provided for the power supply of the AFE control section to avoid control voltage power outage resulting in dropping of all the contactors / breakers.

Closed-loop speed control of AC motor shall be provided with speed reference signal given by the master switch and feed-back signal by the pulse tacho-generator coupled to the main hoist drives.

**05.02.09 Variable Voltage Variable Frequency (VVVF) Drive:**

1.	Basic design particulars	<ul style="list-style-type: none"> <li>- Digital control technology with vector control (with / without PG as per requirement).</li> <li>- IGBT based with sine coded PWM control.</li> <li>- Industrial and continuous duty.</li> <li>- Active front end type for 4 quadrant operation.</li> </ul>
2.	Overload capacity	<ul style="list-style-type: none"> <li>- 150% of the rated current for 1 minute following 100% load in a duty cycle of 5 minute and to meet the drive overload capacity.</li> <li>- 200 % for 3 sec.</li> </ul>
3.	Efficiency	More than 96% at full speed and load.
4.	Input power supply	<ul style="list-style-type: none"> <li>- 415 V AC +10% to -10%.</li> <li>- 50 Hz + / - 5%.</li> <li>- 3 phase, 4 wire neutral earthed system.</li> </ul>
5.	Regulated power supply for reference setting	<ul style="list-style-type: none"> <li>- Voltage variation of (+/-) 0.1 % with an input variation of +10% - 10%.</li> <li>- Steady state regulation of (+/-) 0.25% guaranteed against 100 to 200 % load disturbance and + 3%, - 6% input supply frequency variation.</li> </ul>





एच.ई.सी.

ISO 9001:2000

**HEAVY MACHINE BUILDING PLANT  
HEAVY ENGINEERING CORPORATION LIMITED**

(A Govt. of India Enterprise)

Ranchi – 834 004 (INDIA)

6.	Input reference voltage	- 10 V DC to 0 V to + 10 V DC / 0 - 10 V DC / 4 mA to 20 mA .
7.	Output frequency	0.5 - 400 Hz.
8.	Output frequency resolution	0.01 Hz.
9.	Starting torque	- 150% / 1 Hz. (without PG) - 150% / 0 RPM (with PG)
10.	Torque accuracy	+ / - 5%.
11.	Speed control accuracy	+ / - 0.02%.
12.	Ramp rate	Linear acceleration and deceleration adjustable independently from 0 to 999.9 seconds.
13.	Vibrations	Suitable to withstand vibrations more than 0.5g.
14.	Main power components in incoming AC side	- ACB/MCCB with 50 KA rating - Matching input isolation transformer / Line reactor for harmonic and noise suppression. - AC line surge suppression network. - Input contactor.
15.	Main power components in incoming DC side	- Isolator between common DC bus and VFD
16.	Converter –Inverter Equipment	- IGBT bridge for AC/DC. - DC link circuit with reactor / capacitor. - IGBT bridge for Inverter for DC / AC. - Harmonic transformer.
17.	Load side components	Filter network  Over-load relay for each motor.  Output reactor / terminator(as required)
18.	Protective features	AC line surge suppression network and overvoltage protection.  Under voltage in supply network  Phase sequence protection and monitoring



एच.ई.सी.

ISO 9001:2000

**HEAVY MACHINE BUILDING PLANT  
HEAVY ENGINEERING CORPORATION LIMITED**

(A Govt. of India Enterprise)

Ranchi – 834 004 (INDIA)

		<p>Under voltage in DC bus</p> <p>Over voltage in DC bus</p> <p>Over speed monitor</p> <p>Over load</p> <p>Earth fault</p> <p>Instantaneous over current</p> <p>Transformer fault ,If applicable</p> <p>Cooling fan failure – Stall monitor for motor alarms.</p>
19.	Annunciations	<p>Following faults shall be annunciated in keypad of the drive / HMI.</p> <ul style="list-style-type: none"> <li>- AC line surge suppression network and overvoltage protection.</li> <li>- Under voltage in supply network</li> <li>- Phase sequence protection and monitoring</li> <li>- Under voltage in DC bus</li> <li>- Over voltage in DC bus</li> <li>- Over speed monitor</li> <li>- Over load</li> <li>- Earth fault</li> <li>- Instantaneous over current</li> <li>- Transformer fault ,If applicable</li> </ul> <p>Cooling fan failure</p> <p>Stall monitor for motor alarms.</p> <p>Motor fault (winding / bearing temperature, vibration) as applicable</p> <p>Loss of frequency command</p> <p>Shall be able to store at least 16 previous faults in memory on FIFO sequence.</p>
20.	Meters	Output voltmeter and ammeter (with true RMS reading)



एच.ई.सी.

ISO 9001:2000

**HEAVY MACHINE BUILDING PLANT  
HEAVY ENGINEERING CORPORATION LIMITED**

(A Govt. of India Enterprise)

Ranchi – 834 004 (INDIA)

		with selector switches  Input voltmeter and ammeter (with true RMS reading) with selector switches  Output frequency meter  KW meter for drive ratings above 200 KW
21.	Selector switches	Local / Remote.  Auto / Manual.  Main / Bypass.
22.	Pushbuttons	Trip reset.  Start  Emergency stop
23.	Lamps	Drive ready.  Drive trip.  R, Y, B phase power ON.  Control supply ON.
24.	Regulation & control facilities	Reference speed setter  Ramp generator  Speed feed back  Current feed back  Trigger module  Pulse transformers  Logic control module  Sequence module  PID control  Zero speed / over speed monitor as applicable.  Momentary power loss restart.  Auto tuning.  Current limiter



एच॰ई॰सी॰

ISO 9001:2000

**HEAVY MACHINE BUILDING PLANT  
HEAVY ENGINEERING CORPORATION LIMITED**

(A Govt. of India Enterprise)

Ranchi – 834 004 (INDIA)

		<p>Counter current / regenerative braking unit as applicable</p> <p>Active electronic components used shall be of industrial grade hermetically sealed.</p> <p>Output signals for fault alarm, frequency arrival, running signal.</p>
25.	Remote control facilities	<p>Shall have transducer to monitor the outputs like motor speed at remote place / HMI.</p> <p>Facility to accept speed reference from HMI / engineering station.</p> <p>All software and hardware required for communication and parameterization of drives with PC shall be provided. Any special application program, if developed for a drive, shall also be provided.</p>
26.	Operator panel	<p>Shall be mounted on the front door of the unit.</p>
27.	Membrane keypad	<p>The keypad shall be logically designed for two operating areas with required number of keys.</p> <p>Local operator control like</p> <p>Local start / stop ,</p> <p>Jog forward / reverse.</p> <p>Programming.</p> <p>All PIN / Passwords required to use advance programming features of the drives shall be provided.</p>
28.	LCD display	<p>Display shall be black lighted, enabling viewing in extremes of lighting conditions.</p> <p>Display shall be in alphanumeric (in English only) 16 characters, 2 lines.</p> <p>All the last 16 faults stored in memory (in FIFO sequence) shall be displayed by scrolling.</p>



एच॰ई॰सी॰

ISO 9001:2000

**HEAVY MACHINE BUILDING PLANT  
HEAVY ENGINEERING CORPORATION LIMITED**

(A Govt. of India Enterprise)

Ranchi – 834 004 (INDIA)

29.	Construction features	<p>Floor mounted, free standing</p> <p>Dust and vermin proof</p> <p>Sheet steel clad</p> <p>Minimum 2.5 mm thick for panels.</p> <p>Minimum 2.0 mm thick for doors and side covers.</p> <p>Suitable to withstand vibrations to be encountered in steel plant application.</p> <p>Cubicles with illumination lamps, door switches, space heaters and adequate sockets for power supply to CRO, laptops &amp; soldering.</p> <p>All control blocks plug-in-type with necessary test sockets.</p> <p>Units shall be self contained and serviceable.</p>
30.	Enclosure and ventilation	<p>Enclosure conforming to IP-42 or better with weather proof enclosures.</p> <p>Units shall be provided with cooling fans and louvers at the bottom sides.</p> <p>All louvers shall have fine mesh behind them.</p> <p>Ventilation through individual ventilation ducts, from bottom not acceptable.</p>
1 number of Laptop with necessary software shall be provided for 1 no. of crane.		

**05.02.10 Panels**

There will be suite of control panels in addition to the protective panel.

All panels shall be of free-standing floor-mounting construction, suitable to withstand vibrations encountered on crane. Hinged doors shall be provided for closed type panels. Panels shall be front wired. Front wired live points of bottom most equipment shall be mounted at least 350 mm above the bottom cover of the panel. Panel shall be fabricated from 2 mm thick steel sheet.

Power and control terminals shall be segregated. 10% spare terminals shall be provided in each panel.



एच॰ई॰सी॰

ISO 9001:2000

**HEAVY MACHINE BUILDING PLANT  
HEAVY ENGINEERING CORPORATION LIMITED**

(A Govt. of India Enterprise)

Ranchi – 834 004 (INDIA)

The suite of panel shall have bus-bar located at the top of the panel. The bus-bar chamber at top shall have bolted front cover of approximate height 300 mm. The panel shall be with hinged lift off type door with door swing limitation of 600 mm. The overall height of the panel suite shall be limited to 2300 mm including the mounting channel.

Equipment in the panel shall be so mounted that their removal or replacement from the front is easy. Suitable Door mounted DPM shall be provided for each mechanism for display of motor current. The DPM and associated equipment shall be designed to withstand the ambient conditions and vibrations.

Maximum possible clearances shall be provided between the panels for walkway and to meet I.E. rules. The panels shall be supported in the back from the girder to avoid vibrations. However, AC unit is not included in the scope of this tender and shall be a free issue item by the Purchaser.

Inside each panel, there shall be item designation tags for each item. These shall be placed at a convenient place near irremovable portion of the panel as well as on the body of the item. Equipment designation tags on the fixed portion shall be on Acrylic plate and names shall be embossed. On the item body, the designation tags shall be on printed stickers.

**05.02.11 Switchgears:**

Each drive shall be provided with SFU on incoming sides. MCB shall be provided in the control circuit of each motion. Each brake circuit shall be provided with a suitable contactor. Electronic motor protection relays shall be provided where ever necessary.

MCCB shall be designed at 415 VAC and of minimum short circuit capacity of 50 KA.

Current rating of all equipments shall be based on the motor rated current at specified ambient and duty. The minimum rating of the contactor used shall be 32A and the life of each contactor shall not be less than 10,000 hrs. of operation.

Current rating of the circuit breaker shall be as per requirement. All the circuit breakers shall operate at ambient temperature mentioned in TS. Temperature derating (above the designed temperature of 40 deg. C) shall be considered as per IS / IEC while selecting the circuit breaker.

**05.02.12 Motors:**



एच॰ई॰सी॰

ISO 9001:2000

**HEAVY MACHINE BUILDING PLANT  
HEAVY ENGINEERING CORPORATION LIMITED**

(A Govt. of India Enterprise)

Ranchi – 834 004 (INDIA)

The hoist shall be provided with twin motor drives through planetary gearing so that in case of failure of one of the motors, the other motor shall be utilized to handle the hot metal ladle at half the speed.

Heavy duty reversible crane service, totally enclosed fan cooled, foot mounted, squirrel cage inverter duty motor conforming to latest edition of IS: 325-1996 and IEC-60034 shall be used for various drives. Class of insulation shall be H with temperature rise limited to that for 'F'. Pullout torque to be not less than 250% and 275% of full load torque corresponding to specified duty & ambient for class 3 & 4 duty cranes respectively.

The following guidelines shall be followed for speed ranges of main motor:

a) Class M7 & M8 (III & IV) duty cranes:

Main & auxiliary hoist	:	750 rpm
Long & cross travel	:	1000 rpm

All motors shall have the terminal box at top. Frame sizes shall conform to IEC / IPSS Standards. The enclosure class of terminal box shall conform to IP-55. The terminal box shall be amply dimensioned and suitable to receive copper cables.

The terminal box shall be fitted with suitable glands. A suitable earthing stud shall be provided inside the terminal box for connection of the 4<sup>th</sup> core of the cable.

Horizontal foot mounted and with cylindrical / tapered shaft extension as per requirement.

While selecting the motor rating following shall also be taken into consideration:

- Duty type S4
- Cyclic duty factor
- Number of switching per hours
- Type of controls used
- Inertia of the motor and mechanism
- Ambient correction factor
- Derating for VFD control





एच॰ई॰सी॰

ISO 9001:2000

**HEAVY MACHINE BUILDING PLANT  
HEAVY ENGINEERING CORPORATION LIMITED**

(A Govt. of India Enterprise)

Ranchi – 834 004 (INDIA)

- Wind pressure

Maximum permissible operating speed shall be 250% of synchronous speed or 2000 rpm whichever is less. Over load capacity 150% of full load current for 2 minutes without damage or permanent deformation from zero to base speed.

Motor selection shall be as per IS-4137 and IPSS for temperature derating & VFD derating factor shall be taken as 18%. VFD sizing shall be 150% of motor current at mechanical KW.

Motors will be provided with insulated bearings on NDE side for 280 & above frame size to reduce shaft current.

Motor shall be suitable for peak transient voltage 1600 V and rise time 0.1 microsecond.

The encoder couplings shall have capacity to tolerate Axial, Radial and Transverse displacements.

For details of drive motors including KW rating, rpm, quantity & no of starts / hr please refer motor list at clause number **02.02.18**.

**05.02.13 Master controller:**

Cam type master controller with joy stick type lever shall be used. Separate master controllers for hoist, LT & CT shall be provided. Dual master controller operated with single handle shall not be used. Master controller for each motion controls shall have 5-0-5 notches in each direction. Arm chair control unit is in the tenderer's scope.

**05.02.14 Lighting, socket outlets, bells etc.**

Separate lighting distribution board (LDB) shall be provided for crane illumination and incoming power supply to the LDB shall be tapped from load break isolator switch located after main current collectors.

Lighting shall be provided in operator's cabin, staircases, platforms and working areas.



एच॰ई॰सी॰

ISO 9001:2000

**HEAVY MACHINE BUILDING PLANT  
HEAVY ENGINEERING CORPORATION LIMITED**

(A Govt. of India Enterprise)

Ranchi – 834 004 (INDIA)

Minimum 4 nos. 400 watts high pressure sodium vapour flood lights equally spaced (under crane girders) about the crane span shall be provided along with shock absorbing and anti-swing suspension arrangements. More numbers of fittings shall be provided if required for cranes with longer span and / or longer height of lift.

Fluorescent lamps (CFL) with necessary fittings shall be used for operator's cabin, staircases, platforms etc.

Adequate number of hand lamp socket outlets (2 Pin, 10A, 24V) and power socket outlets (3 Pin, 20A, 240V & 110V) shall be provided along with switches. Socket & switch shall be interlocked suitably. A hand lamp (160W SLS lamp with enclosed type battery and wire guard) along with sufficient length (15m) of cable with a plug shall also be provided for each crane.

An alarm bell shall be provided on each crane.

**05.02.15 Equipment in operator's cabin**

The operator's cabin shall contain the following:

- Master controllers for all the motions (wherever applicable).
- Emergency stop push button.
- Foot switch for alarm or bell (An extra mechanical bell to be provided in the crane cabin).
- Switches for all lighting equipment on crane.
- Switches for exhaust fan and for cabin fan.
- A fire extinguisher.
- Insulating mat and operator's chair.
- Cabin light.



एच०ई०सी०

ISO 9001:2000

**HEAVY MACHINE BUILDING PLANT  
HEAVY ENGINEERING CORPORATION LIMITED**

(A Govt. of India Enterprise)

Ranchi – 834 004 (INDIA)

Annunciation panel with indication lamps for power 'ON' control 'ON' emergency corner switch operated, ammeter and voltmeter with selector switches.

**05.02.16 Enclosure Class**

- a) For indoor operations
- Motors : IP: 55
  - All other electric equipment : IP: 54
  - VFD & AFE panels : IP: 42 or better enclosure

**05.02.17 Cables:**

Power cable suitable for 3 Phase, 4 wire, AC power supply system.

All cables shall have stranded copper conductors. All cables on the cranes shall be copper. Control wiring shall be with 2.5 mm<sup>2</sup> copper; minimum size of power cable shall be 6 mm<sup>2</sup> copper. Fixed wiring on cranes shall be carried out with HRPVC insulated, HRPVC sheathed armoured cable or EPR insulated CSP sheathed cable or better.

All flexible cables (i.e. cables for trolley, feed, pendant unit etc.) shall have copper conductor, EPR insulation and CSP sheathing or better.

All cable shall be suitably de-rated for grouping and higher ambient temperature.

All cables shall be of 1100 Volts grade.

All accessories like cable glands, lugs, clamps, pipes, wire and terminal marks etc. shall also be provided.

Cable laying and terminations shall be such that the chances of cables getting damaged is remote.

Cable sizes shall be selected considering motor current at mechanical KW.

In all passages and on trolley the cable shall be laid in trays and shall be covered by similar trays and properly clamped & fixed.

a) LT Power Cable

1.1 kV, heavy duty power cable, 4 core with stranded sector shaped (sm) or with compact circular stranded (rm/V) or circular stranded (rm) Copper conductors as applicable, HRPVC insulated suitable for 85°C operation as per IS: 5831-1984, core stranded together provided with a common covering of HRPVC inner sheath, galvanized round steel wire



एच॰ई॰सी॰

ISO 9001:2000

**HEAVY MACHINE BUILDING PLANT  
HEAVY ENGINEERING CORPORATION LIMITED**

(A Govt. of India Enterprise)

Ranchi – 834 004 (INDIA)

armoured and HRPVC outer sheathed, multi core conforming to IS: 1554 (Part-I – 1988) Type YWY.

b) Control Cables

1.1 kV, circular stranded (rm), annealed copper conductor, HRPVC insulated suitable for 85°C operation, as per IS:5831-1984, cores stranded together provided with a common covering of HRPVC inner sheath, galvanized round steel wire armoured and HRPVC outer sheathed, multi-core similar to IS:1554- (Part-I)-1988, Type YWY. All the individual cores shall be marked for identification.

c) Flexible Trailing Cable

1.1 kV grade, heavy duty type with tinned annealed high conductivity flexible copper conductors, ethylene propylene (EPR) insulated and chlorosulphorated polyethylene (CSP) sheathed conforming to IS: 8130-1984, IS: 6380-1984 and IS: 9968 (Part-I)-1988.

**05.02.18 Earthing**

A ring earthing system shall be provided on the crane. Each and every electrical equipment shall be connected to this earthing at least at two points. However the electronic circuit insulated earth wire shall run in panel and terminate at main earth connection only at one point. The earthing shall be connected to the fourth trolley line in DSL system through 2 nos of current collector. All these collectors shall be connected to earthing ring.

An earth core shall be provided in trolley feed cable. The cable reeling drum shall have a separate slip ring for earthing purpose. It shall conform to general specification for earthing.

Rubber matting's shall be provided in front of the protective and control panels. All bonds between earth conductors and crane parts shall be welded if possible, or riveted and soldered. Where screwed bonds are made, care shall be taken that there is satisfactory contact surface and nuts shall be locked to prevent their loosening. Earth connections to equipment shall be made by means of multi strand flexible conductor to adequate section.

The earth ring on the crane/ machine shall be connected to the plant earthing system through to gantry rails. Each end of each gantry rail shall be bonded to the plant earthing system.



एच०ई०सी०

ISO 9001:2000

**HEAVY MACHINE BUILDING PLANT  
HEAVY ENGINEERING CORPORATION LIMITED**

(A Govt. of India Enterprise)

Ranchi – 834 004 (INDIA)

In addition, intermediate earthing bond shall also be provided on the rails at every 60 m in case of longer tracks.

Flexible copper bonds shall be provided across any gap in the running gantry rail.

**05.02.19 Colour code for electrical equipment**

Sl. No.	Description of equipment	Colour	Paint shade No. as per	
			IS : 5-1991	Equivalent RAL Code
I	MOTOR			
1.	LT AC Motors (415V or below)	Brilliant Green	221	6010
II	Mounted Electrics			
1.	Equipment installed on or along with motor (Viz Tacho-generators, brake etc.)	Same as that of motor		
2.	Equipment installed on mechanism but separate from motor (Viz. Limit switches, pull cords, speed switches, load cells, photo elec. relays etc.)	Light Gray	631	7042
III	415V switch gear (Substation equipment)	Brilliant Green	221	6010
IV.	Control Gear			
1.	All control panels (MCCs, PDBs, thyristor panels etc.)	Light Admiralty Gear	697	7001
2.	Light distribution board	Brilliant Green	221	6010
3.	Local control box	Light Gray	631	7042
4.	PLC, UPS, Control desk Mimic panel	Light Gray	631	7042
5.	Pulpit equipment	Light Gray	631	7042
V.	Miscellaneous Equipment			
1.	Junction boxes		631	7042
2.	Conduit pull boxes		631	7042
3.	Light fittings		631	7042
4.	110 V and 24 V transformer, sockets, lamp sets etc.	Canary yellow	309	1016
5.	Earthing strip	Black		
6.	Battery charger	Brilliant Green	221	6010
8.	DC DB	Oriental Blue	174	5018
9.	Battery charger cum DC DB	Brilliant Green	221	6010



एच॰ई॰सी॰

ISO 9001:2000

**HEAVY MACHINE BUILDING PLANT  
HEAVY ENGINEERING CORPORATION LIMITED**

(A Govt. of India Enterprise)

Ranchi – 834 004 (INDIA)

**06.00 PERFORMANCE & GUARANTEE:**

After erection and commissioning of equipment, performance tests shall be carried out to prove the performance of the system and equipment.

These tests shall be binding on both the parties of the contract to determine compliance of the equipment / system with the performance guarantee.

The tenderer will exhibit PAT test, commissioning test, Performance guarantee tests and FAT test as per parameters defined in this technical specification for the equipment under scope of work.

All the instruments for the performance tests, as required, shall be supplied by the tenderer and shall be retained by him till the satisfactory conclusion of all tests at site. All costs associated with the supply, calibration, installation and return of test equipment shall be included in the scope of supply. All test instruments shall be as per standards approved by the Employer.

- 06.01** The cranes after erection shall be undergo PAT test for visual inspection, no load trial runs and various components shall be inspected for smooth running, vibrations and abnormal temperature rise etc.
- 06.02** After rectification of major PAT defects, the cranes shall be tested as per IS-4137-1985, Reaffirmed- 2006 - Code of Practice for Heavy duty Electric Overhead Travelling Cranes including Special Service Machines for use in Steel Works which shall be deemed as both commissioning test and PG test. Test load (ingots / slabs etc) shall be identified by the client within the plant boundary. The tenderer shall arrange to bring the test load to site and transport it back to its original location or any other location identified by the client within plant boundary.
- 06.03** Cranes shall deemed to be successfully commissioned after all the tests as per IS-4137-1985, Reaffirmed- 2006 - Code of Practice for Heavy duty Electric Overhead Travelling Cranes including Special Service Machines for use in Steel Works are carried out satisfactorily.
- 06.04** The tenderer shall supervise and carry out the operation under their instruction and guidance during performance guarantee tests and shall take full responsibility of the operation. The purchaser will make available necessary operating and maintenance personnel as per the agreed manning schedule as well as the raw materials, utilities and services etc, as specified.



एच०ई०सी०

ISO 9001:2000

**HEAVY MACHINE BUILDING PLANT  
HEAVY ENGINEERING CORPORATION LIMITED**

(A Govt. of India Enterprise)

Ranchi – 834 004 (INDIA)

**06.05** The tenderer shall submit the scope, general preconditions, test procedures, guaranteed values and test evaluation methods which shall be finalized during performance guarantee tests.

**06.06** The performance tests for all plant equipment shall be carried out to satisfy all operating parameters as per the relevant clauses of the technical specification for the equipment under consideration.

**06.07** The electrical system for the crane shall be guaranteed for a period as per commercial part of this contract (SBD).

**06.08** If the successful tenderer fails to achieve the guarantee and performance parameters, he shall investigate the causes and shall rectify and/or replace, free of cost to the Employer the defects of the equipment/system within a period of 1 (one) month from the date of commencement of performance and guarantee tests and again prove the guarantees. In such cases, the cost of modifications including labour, materials, and cost of additional testing etc. shall be borne by tenderer.

If even after necessary alteration and modifications are affected, the performance guarantees are not fulfilled, the Employer reserves the right to reject the equipment. In the event of exercising this right, the tenderer shall replace the defective equipment / system with the equipment / system that meet the performance guarantee parameters. The cost of replacement inclusive of labour, materials and repeat testing to prove compliance with the performance guarantees shall be borne by the tenderer.

**06.09** The following basic performance parameter tests shall be concluded:

- a. All equipment shall operate at rated capacity without undue vibration and undue noise etc.
- b. Measurement of noise and vibration levels.
- c. Measurement of power consumption of various drive motors while operating at performance guarantee levels.
- d. Continuous run system performance test.

All other parameters of the equipment or system indicated in the specification / relevant IS/IPSS codes.

**07.00 DOCUMENTATION**

**07.01 Information to be furnished by the Tenderer along with the offer:**

The Tenderer shall submit following technical drawings & technical data/information with tender for cranes without which the tender shall be considered as incomplete & may not be considered for acceptance.





एच॰ई॰सी॰

ISO 9001:2000

**HEAVY MACHINE BUILDING PLANT  
HEAVY ENGINEERING CORPORATION LIMITED**

(A Govt. of India Enterprise)  
Ranchi – 834 004 (INDIA)

- a. The technical specification duly stamped and signed as a token of acceptance.
- b. Deviations from tender documents in the format enclosed as Annexure- II.
- c. List of commissioning spare & list of spares for two (2) years normal operations for each crane as per clause no 03.01 and 03.02.
- e. Other supporting documents as per clause no. 04.18 i, ii & iii.
- f. Un-priced copy of list of equipment.
- g. Motor & Component list.
- h. Technical details of AFE converters, VFDs etc.
- i. Single line diagrams / Block Diagram of control panels, AFEs, VFDs, LDBs etc.
- j. Connected load and 30 minute maximum demand.
- k. List of Makes.
- l. Motor GA drg. & motor datasheet.

**07.02 List of drawings / documents to be furnished by the successful tenderer.**

Following drawings shall be submitted in adequate number of copies as per relevant IS and IPSS for each crane for approval / reference within one month of issue of letter of Intent and prior to commencement of manufacture for approval by FFP/HEC. However, approval of drawings by the Employer will not relieve the supplier of his responsibilities for correctness, adequacy of the design and completeness of his work as per the contract.

All the drawings and documents will be in English language. Drawings shall be complete in all respects with dimensions, item lists, weights, sub-supplier's name etc.

- i Layout of cabin showing the location and fixing of all the equipment inside it such as controllers / operator's seat, protective panel, isolating and control switches, fire extinguishers, exhausts and circulating fans, air conditioners etc. (for approval)
- ii a) Power and control circuit diagram showing the wiring for all the panels for crane including the speed torque characteristics of each motion.



एच॰ई॰सी॰

ISO 9001:2000

**HEAVY MACHINE BUILDING PLANT  
HEAVY ENGINEERING CORPORATION LIMITED**

(A Govt. of India Enterprise)

Ranchi – 834 004 (INDIA)

- b) Layout of Electrical equipment on crane, cable layout drawings and layout of earthing system for equipment installed on crane.
- c) Inter-connection diagram and cable schedule.
- d) Current collection arrangement for the crane and details of current collector.
- e) Power supply arrangement (details) to the trolleys and attachments.
- f) GA of all panels, arm chair units, junction boxes, and master controllers etc. with their technical details.
- g) Bill of materials for each panel and terminal plan drawings for each and every panel and equipment.
- h) Single Line Diagrams for various panels
- i) Power and regulation schemes for AFEs & VFDs.
- j) Power and control schemes with bill of materials and technical specification.
- k) Motors, VFD and field devices
  - GA drawings
  - Technical data sheet
  - Characteristic curves for motors
- l) Cable selection chart & cable data sheet.
- m) Ordering specification for major bought outs and technical catalog for all electrical components.
- n) Manual for operation and maintenance.

iii Quality Assurance Plan for inspection

NOTE: QAP, inspection and testing of equipment shall be as per inspection procedure mutually agreed.

- iv In addition to the above, the purchaser may ask for submission of other drawings, documents and electrical calculations of the crane for scrutiny and reference, if required.

**07.03 List of drawings / documents to be submitted along with equipment by the successful tenderer.**

- a. GA drawings for all the panels and other devices.
- b. Drawings of all equipment/component received from sub supplier.



एच०ई०सी०

ISO 9001:2000

**HEAVY MACHINE BUILDING PLANT  
HEAVY ENGINEERING CORPORATION LIMITED**

(A Govt. of India Enterprise)

Ranchi – 834 004 (INDIA)

- c. Engineering and design calculations for all installations and units.
- d. Test and warranty certificate for each item of equipment.
- e. Test reports and inspection reports.
- f. Instruction manuals for testing and commissioning.
- g. Operation, maintenance and safety manuals.
- h. Requirement of special tools and tackles, if any, for subsequent maintenance.
- i. Detail drawing list and specifications / technical catalog for all electrical components.
- j. List of spare parts with specifications and manufacturer's catalogue.
- k. Erection drawings including equipment & cable layout drawings, inter-connection drawing, cable schedule etc.

### 8.00 LIST OF PREFERRED MAKES OF ELECTRICAL PARTS

The make of the equipments shall be as per the preferred make list of FFP/HEC. Makes of item not included in the list shall be subject to approval by FFP/HEC.

L V EQUIPMENTS		
Sl. No.	Equipment	Preferred Makes
1A	MOULDED CASE CIRCUIT BREAKER (MCCB)	SCHNEIDER (CG & MG), L&T ANDREW YULE, ABB, SIEMENS, BCH (BIL), GE POWER CONTROL, MOELLER, CONTROL & SWITCHGEAR.
1B	AIR CIRCUIT BREAKER	L&T, SIEMENS, SCHNEIDER, ABB, GE POWER CONTROL
2	MOTOR PROTECTION CIRCUIT BREAKERS (MPCB)	SCHNEIDER (TELEMECANIQUE), L&T, ABB, GE POWER CONTROL, MOELLER, ROCKWELL AUTOMATION, CONTROL & SWITCHGEAR.
3	MINIATURE CIRCUIT BREAKER (MCB)	SIEMENS, L&T, GE POWER CONTROL, SCHNEIDER (PROTEC/MG), STANDARD, INDO-ASIAN HAVELLS, MDS (LEGRAND), ABB, CONTROL & SWITCHGEAR.



एच.ई.सी.

ISO 9001:2000

**HEAVY MACHINE BUILDING PLANT  
HEAVY ENGINEERING CORPORATION LIMITED**

(A Govt. of India Enterprise)

Ranchi – 834 004 (INDIA)

4	EARTH LEAKAGE CIRCUIT BREAKER	GE POWER CONTROL, STANDARD, HAVELLS, ABB, SIEMENS, SCHNEIDER.
5	SWITCH FUSE UNIT / FUSE DISCONNECTOR (FUSE SWITCH UNIT), AIR BREAK SWITCH	GE POWER CONTROL, L&T, SIEMENS, BASANT PRAN & CO, HAVELLS, STANDARD, INDO-ASIAN, CONTROL & SWITCH GEAR, ANCHORE.
6	HRC FUSE FOR LT APPLICATION	GE POWER CONTROL, L&T, SIEMENS, BHARAT LINDER, INDO ASIAN, HAVELLS, STANDARD, BUSSMAN, CONTROL & SWITCH GEAR, ABB.
7	POWER CONTACTOR FOR CRANE / MILL DUTY OPERATION	
7.1	BOX TYPE (AC/DC)	ABB, SIEMENS, SCHNEIDER, (TELEMECANIQUE), L&T, MOELLER, GE POWER CONTROL, ROCKWELL, AUTOMATION, CONTROL & SWITCHGEAR (TRIAL PARTY)
7.2	VACUUM CONTACTOR	SIEMENS, L&T, MOELLER, ABB, SCHNEIDER (TELEMECANIQUE).
7.3	AC/DC POWER CONTACTOR – CLAPPER TYPE / BAR MOUNTED – MILL DUTY / CRANE DUTY	BCH (BIL), BHEL, L&T, SCHNEIDER (TELOMECANIQUE), GE (USA), ABB, LENIOR ELEC (FRANCE), MICROELECTRICA SCIENTIFIC (ITALY)
8	POWER CONTACTOR FOR GENERAL PURPOSE & CONTINUOUS DUTY OPERATION	ABB, SIEMENS, SCHNEIDER, L&T, ROCKWELL AUTOMATION, ANDREW YULE, SCHNEIDER (CG) BCH (BIL), MOELLER, CONTROL & SWITCH GEAR
9	OVER LOAD RELAY	
9.1	THERMAL (BIMETALLIC)	BCH (BIL), L&T, SIEMENS, SCHNEIDER (TELOMECANIQUE), ANDREW YULE, SCHNEIDER (C.G.), ROCKWELL AUTOMATION, CONTROL & SWITCHGEAR.
9.2	ELECTRONIC OVER LOAD RELAYS	SIEMENS, L&T, ROCKWELL AUTOMATION, MOELLER, BCH, SCHNEIDER – SAMWHA
9.3	ELECTRO MAGNETIC OVER LOAD RELAY	BCH, KILBURN, BHEL, SCHNEIDER (TELEMECANIQUE)
10	AUX. CONTACTORS / CONTROL RELAYS	OEN, L&T, SCHNEIDER, ANDREW YULE, GE POWER CONTROL, BCH (BIL), EASUN



एच.ई.सी.

ISO 9001:2000

**HEAVY MACHINE BUILDING PLANT  
HEAVY ENGINEERING CORPORATION LIMITED**

(A Govt. of India Enterprise)

Ranchi – 834 004 (INDIA)

		REROLLE, JYOTI, ROCKWELL AUTOMATION, CONTROL & SWITCHGEAR.
11	TIME DELAY RELAY	
11.1	ELECTRO PNEUMATIC	BCH (BIL), SCHNEIDER (TELOMECANIQUE), BHEL, ESAUN REFOLLE
11.2	ELECTRONIC TIMER	SELECTION, SIEMENS, BCH (BIL), ALSTOM, L&T, ROCKWELL AUTOMATION IFM, SCHNEIDER (TELOMECANIQUE)
11.3	TIME SWITCHES	L&T, GE POWER CONTROL, EAPL, INDO ASIAN, SCHNEIDER (MG)
12	MASTER CONTROLLER	EPCC, INDUSTRIAL SYNDICATE, STROM KRAFT, SCHNEIDER (SQUARE D), SCHNEIDER (TELEMECANIQUE)
13	LIMIT SWITCHES	
13.1	CRANE & HEAVY DUTY APPLICATION	EPCC, SCHNEIDER, INDUSTRIAL SYNDICATE, STROM KRAFT, JAI BALAJI
13.2	MICRO & OTHER ACTUATING TYPE	ESSEN DEINKI, L&T, BCH (BIL), SIEMENS, SCHNEIDER (TELEMECANIQUE), JAI BALAJI
14	ELECTROMAGNETIC DC BRAKE ASSEMBLY	EPCC, BCH (BIL), INDUSTRIAL SYNDICATE
POWER CONTROL AND ELECTRONICS ITEMS		
15	PLC	ROCKWELL AUTOMATION, L&T (QUANTAM), SIEMENS, ABB, GE FANUC, BCH, SCHNEIDER
16	VVVF DRIVES	ABB, BHEL, SIEMENS, L&T, (YASKAWA), SCHNEIDER, VACON, ROCKWELL AUTOMATION, SSD, JELTRON (TOSHIBA)
17	POWER DIODES	RUTTON-SHAW, USHA RECTIFIER, HIND RECTIFIER, INSEL, SEMIKRON RECTIFIER, WEST CODE, EUPEC
18	CONTROL DIODES	ECIL, BEL, HIND RECTIFIER, INSEL
19	SEMICONDUCTOR FUSES	GE POWER CONTROL, SIEMENS, LA-



एच.ई.सी.

ISO 9001:2000

**HEAVY MACHINE BUILDING PLANT  
HEAVY ENGINEERING CORPORATION LIMITED**

(A Govt. of India Enterprise)

Ranchi – 834 004 (INDIA)

		FERRAZ, BUSSMAN
20	UPS FOR INDUSTRIAL DUTY	HI-REL, ILK (FUJI), TATA LIBERT (EMERSON), SIEMENS, DB POWER ELECTRONIC (P) LTD, APLAB
MOTOR		
21	LT SQUIRREL CAGE MOTORS	ABB, BHARAT BIJLEE, CGL, KEC, MARATHON, SIEMENS
22	PROXIMITY SWITCHES (INDUCTIVE, CAPACITIVE AND MAGNETO)	IFM, SIEMENS, SICK, ROCKWELL AUTOMATION, PEPPERL FUCHS, SCHNEIDER
23	ENCODER	IFM, HUBNERM, HEIDENDINE, LEONARD, DIPL, ENG.H. WENGORZ, GmbH, SICK
24	ZERO SPEED SWITCH	SCHNEIDER – SAMWHA, IFM, ROCKWELL AUTOMATION, SIEMENS, PEPPERL + FUCHS, PYROTECH
25	SENSORS / SWITCHES *LIGHT BARRIERS *DISTANCE *LEVEL	IFM, SICK, ROCKWELL AUTOMATION, BHEL, SEHNIEDER, HONEYWELL
PANELS & PANEL COMPONENTS (LOW VOLTAGE)		
26	PANEL ENCLOSURES	EPCC, BCH, RITTAL, TRANSRECT, ADVANCE POWER CONTROL, CONTROL & SEITCHGEAR
27	CONTROL TRANSFORMERS	AEI, UNITECH, EPI, POWER & COMMUNICATIONS, TRANSRECT, ADVANCE POWER CONTROL, EEW, CONTROL & SWITCHGEAR
28	MAIN LIGHTING DISTRIBUTION BOARD (MLDB)	SIEMENS, L&T / ECC, TRANSRECT, HAVELLS, STANDARD, SCHNEIDER ELECTRIC, MAHESWARI ELECT., GE POWER CONTROL, EEW (EEW FOR INDOOR APPLICATION AND UPTO 200 A ONLY), MDS, ADVANCE POWER CONTROL, TRIAL PARTIES – MEDITRON, SWITCHING CKT., S&S, CONTROL & SWITCHGEAR.



एच०ई०सी०

ISO 9001:2000

**HEAVY MACHINE BUILDING PLANT  
HEAVY ENGINEERING CORPORATION LIMITED**

(A Govt. of India Enterprise)

Ranchi – 834 004 (INDIA)

29	PUSH BUTTONS	GE POWER CONTROL, BCH, CONTROL & SWITCH GEAR, L&T, SIEMENS, TECHNIK, ESSEN, TELEMECHANIQUE.  TRIAL PARTIES – VAISHNO, S&S.
30	INDICATING LED LAMP ASSEMBLY	BINOY, ESSEN DEINKI, SIEMENS, TECHINK, BCH, L&T, ALTOS, CONTROL & SWITCHGEAR.
CABLES		
1	RUBBER CABLES (IS-9968 PT-1) (EPR/CSP, VIR/TRS & SR CABLES)	1) IMT CABLES 2) Nangalwala Impex 3) United Cables 4) Bhagwati Cables 5) Cable Corpo of India 6) Govind Cables 7) KEI Industries 8) NICCO Cables 9) Shyam Cables 10) Sky Tone Elect. 11) Uniflex Cables 12) Universal cables 13) Serval Cables 14) K. N. G. PLASTIC 15) Mansfield Cables 16) R. J. Elect. 17) BMI Cables 18) TERACOM Pvt. Ltd.
32	HRPVC CABLES (IS-1554: PT-1:88 - License Endorsed for Insulation of Type C & sheath ST2)  (Power & Control Copper & Aluminium – Armored & Unarmored)	1) Ajanta Elect. 2) Fine cab Cable 3) Insucon Cable 4) KEI Industries 5) Shanti Cables 6) Shyam Cables 7) Serval Cables 8) GEMS Cab 9) Mans Field Cables 10) Pagoda Cables 11) Universal Cables 12) Electrical Cable Indu. 13) Special cable 14) BMI Cables 15) Brimson Cables 16) RJ Indu. 17) Diamond Power 18) Grid India power cable 19) Bhansali Cables 20) Kalinga Cables & conduit Co. 21) Asian cable Co, Raigarh 22) Paragon cable India Ltd.



एच.ई.सी.

ISO 9001:2000

**HEAVY MACHINE BUILDING PLANT  
HEAVY ENGINEERING CORPORATION LIMITED**

(A Govt. of India Enterprise)

Ranchi – 834 004 (INDIA)

LAMPS & FIXTURES		
33	LAMPS (GLS)	PHILIPS, BAJAJ, OSRAM, MYSORE LAMPS, SURYA ROSHNI, CROMPTON GREAVES, G.E. LIGHTING, WIPRO
34	LIGHTING FIXTURES	PHILIPS, BAJAJ, MYSORE LAMPS, CROMPTON GREAVES, G.E. LIGHTING, WIPRO, DEEPCON
35	LEAD ACID STATIONARY BATTERY	EXIDE, AMCO, AMARA RAJA
36	NICKLEL CADMIUM BATTERIES	AMCO, SAB-NIFE
37	BATTERY CHARGERS	CHHABI ELECTRICALS, STANDARD, HI-RECT, SHERENE ELECTRO CONTROL, AMARA RAJA

**Annexure-I****OPERATING / PERFORMANCE PARAMETERS****01) 50/12.5 T x 20.1 M EOT Crane**

Sl. No.	Description	Operating Parameters	
1.	Capacity	50/12.5 T	
2.	Span	20.1 M	
3.	Quantity	One	
4.	Location	RS Bay	
5.	Duty Class	IS 4137-85, M8	
6.	Gantry Rail Level	+16.5 M	
7.	Height of lift	Main Hoist - Below Ground : - 21M	
8.	Run way length	201M	
10.	Wheel base in mm	Trolley : 3880mm LT : 5800mm	
11.	Over buffer dimension in mm	8000 mm	
12.	Type of operation	Operator's cabin	
14.	Speeds, m/min.	Main Speed	Creep Speed
	i) Main Hoist	5 M / min	0.5 M/ min
	ii) Aux. Hoist	15.5 M / min	1.55 M/ min
	iii) Cross Travel	20 M / min	2.0 M/ min
	iv) Long Travel	80 M / min	8.0 M/ min





एच॰ई॰सी॰

ISO 9001:2000

**HEAVY MACHINE BUILDING PLANT  
HEAVY ENGINEERING CORPORATION LIMITED**

(A Govt. of India Enterprise)

Ranchi – 834 004 (INDIA)

15. Acceleration, cm/sq. sec.  
i) Long Travel  $a = 19 \text{ cm / sec}^2$   
ii) For Cross Travel  $a = 10 \text{ cm / sec}^2$
16. Ambient Temperature  $50^\circ \text{ C}$
17. Power Supply  $415\text{V} \pm 10\%$ , 3  $\emptyset$  AC, 50 Hz  $\pm 5\%$
18. Control Voltage  $240\text{V} \pm 10\%$ , 1  $\emptyset$  AC, 50 Hz  $\pm 5\%$
19. Power feeding Through DSL system
20. No. of starts/Hr. S4-40% 150 st/hr for Hoist  
S4-40% 150 st/hr for Travel
- 21 Any other lifting arrangement Winch of 3 Ton



एच॰ई॰सी॰

ISO 9001:2000

**HEAVY MACHINE BUILDING PLANT  
HEAVY ENGINEERING CORPORATION LIMITED**

(A Govt. of India Enterprise)

Ranchi – 834 004 (INDIA)

**Annexure- II**

**Format for deviations**

Sl. No.	Clause No.	Deviations	Amount of variation (+/-) to retain the tender conditions	Reason for Deviation

The Tenderer hereby certifies that the above mentioned are the only deviations from the tender documents.

**Signature** :

**Name** :

**Designation** :

**Company Seal**



एच०ई०सी०

ISO 9001:2000

# HEAVY MACHINE BUILDING PLANT HEAVY ENGINEERING CORPORATION LIMITED

(A Govt. of India Enterprise)  
Ranchi – 834 004 (INDIA)

3339.094.001		PRODUCED BY AN AUTODESK EDUCATIONAL PRODUCT	
<p><u>FFP, HEC</u> <u>02 SHOP</u> <u>SINGLE LINE DIAGRAM FOR 50/12.5T X 20.1M SPAN</u> <u>D.G. E.O.T CRANE</u></p>			
INDEX	N.O.	DESCRIPTION	REVISION SIGNATURE DATE
PRODUCED BY AN AUTODESK EDUCATIONAL PRODUCT			
		50/12.5T X 20.1M D.G. EOT CRANE, FFP (02 SHOP)	
DESIGNED BY <b>S. K. SINGH</b>	CHECKED BY <b>T. K. SART</b>	SCALE: 1/10	SHEET 1 OF 9
DRAWN BY <b>K. GATYAN</b>	H.E.C. 1 TIL, RANCHI	<b>H.M.B.</b>	APRIL 19 REV 0



एच०ई०सी०

ISO 9001:2000

# HEAVY MACHINE BUILDING PLANT HEAVY ENGINEERING CORPORATION LIMITED

(A Govt. of India Enterprise)  
Ranchi – 834 004 (INDIA)

1	2	3	4	5	6	7	8
33.39.094.001		PRODUCED BY AN AUTODESK EDUCATIONAL PRODUCT					
LIST OF CRANES 1 -							
BAY	CRANE CAPACITY	N/L UP CRANES	LIFTING RATIO FV/FI	AMBIENT TEMPERATURE			
R-S BAY	50/125 I X 20.1M	1	+16.50M	50°C			
REVISION	SIGNATURE	DATE	THE DRAWING AND SPECIFICATIONS ARE SOLE PROPERTY OF HEC. IN THE EVENT OF ANY DISCREPANCY BETWEEN THE DRAWING AND THE SPECIFICATIONS, THE SPECIFICATIONS SHALL PREVAIL.				
REVISION	SIGNATURE	DATE	CHECKED BY: T. K. SAHU DRAWN BY: H. K. SAHAI DESIGNED BY: H. K. SAHAI APPROVED BY: H. K. SAHAI				
				Single Line Diagram of 50T/125T X 20.1M D.G. BOT CRANE P.P. (02 SHOP)			
3339.094.001	SHEET NO.	2					
NEXT SHEET	REV-0						



एच०ई०सी०

ISO 9001:2000

**HEAVY MACHINE BUILDING PLANT  
HEAVY ENGINEERING CORPORATION LIMITED**

(A Govt. of India Enterprise)  
Ranchi – 834 004 (INDIA)

MECHANISM		CRANE DUTY S.Q. CAGE INDUCTION MOTOR		VFD		AFE		D.C. BRAKE		RECTIFIER PANEL			
FRAME KW AT 40°C SLIDUTY	Mech Power (KW)	RPM (SYND)	DUTY & CDF	STARTS PER HR	FRAME SIZE	QTY. of Motor	MINIMUM RATING AT 40°C	QTY.	MINIMUM RATING AT 40°C	QTY.	DIA. IN MM	QTY.	
MH	44.90	750	S4, 40%	150	315M	1	149A	1			ø300	2	1
AH	34.54	750	S4, 40%	150	280M	1	105A	1			ø300	1	1
CT	3.67	1000	S4, 40%	150	160M	1	17A	1	*		ø200	1	1
LT	23.01	1000	S4, 40%	150	280S	2	159A	1	1+1(stand by)		ø300	2	1

POWER SUPPLY FOR MOTORS : 415V ±10%, 50Hz ±5%, 3ph  
 CONTROL SUPPLY : 240V ±10%, 50Hz ±5%, 1ph  
 LIGHTING SUPPLY : 240V, 50Hz ±5%, 1ph  
 BRAKE SUPPLY : 415V, AC 50Hz, 1ph  
 FAULT LEVEL : 50 KA FOR 1 SEC.  
 AMBIENT TEMP. : 50° C

**DETAILS OF DRIVE MOTORS & BRAKE :-**

- Note:-
1. Electrical Kw and motor frame sizes are tentative and shall be confirmed by vendors.
  2. Current ratings are tentative estimated values and shall be finalized after finalization of motors.
  3. Heavy duty rating of the inverter shall be min 150% of the motor current at mech. KW.
  4. Current rating of the AFE at 50 degree cel. is sum of current rating of selected inverters at 50 degree celcius two largest mechanisms (Main hoist and Long travel).
  5. Motors with frame size 280M & above shall be provided with insulated bearings at NDE side.

REVISION	DATE	SIGNATURE	DATE	REVISION	DATE	SIGNATURE	DATE

HEC EXCLUSIVE PROPERTY OF HEC LTD.  
 UNAUTHORIZED USE OR MAKING COPIES  
 WITHOUT WRITTEN PERMISSION ARE  
 STRICTLY PROHIBITED

DESIGNED BY: **DR. K. S. SINGH**  
 CHECKED BY: **DR. K. SINGH**  
 DRAWN BY: **DR. K. SINGH**  
 APPROVED BY: **DR. K. SINGH**



Single Line Diagram of  
 50T/125T-20.1M D.G. BOY CRANE  
 PFP (02 SHOP)

3339.094.001  
 SHEET NO. 3  
 NEXT SHEET  
 REV-0



एच०ई०सी०

ISO 9001:2000

# HEAVY MACHINE BUILDING PLANT HEAVY ENGINEERING CORPORATION LIMITED

(A Govt. of India Enterprise)  
Ranchi – 834 004 (INDIA)

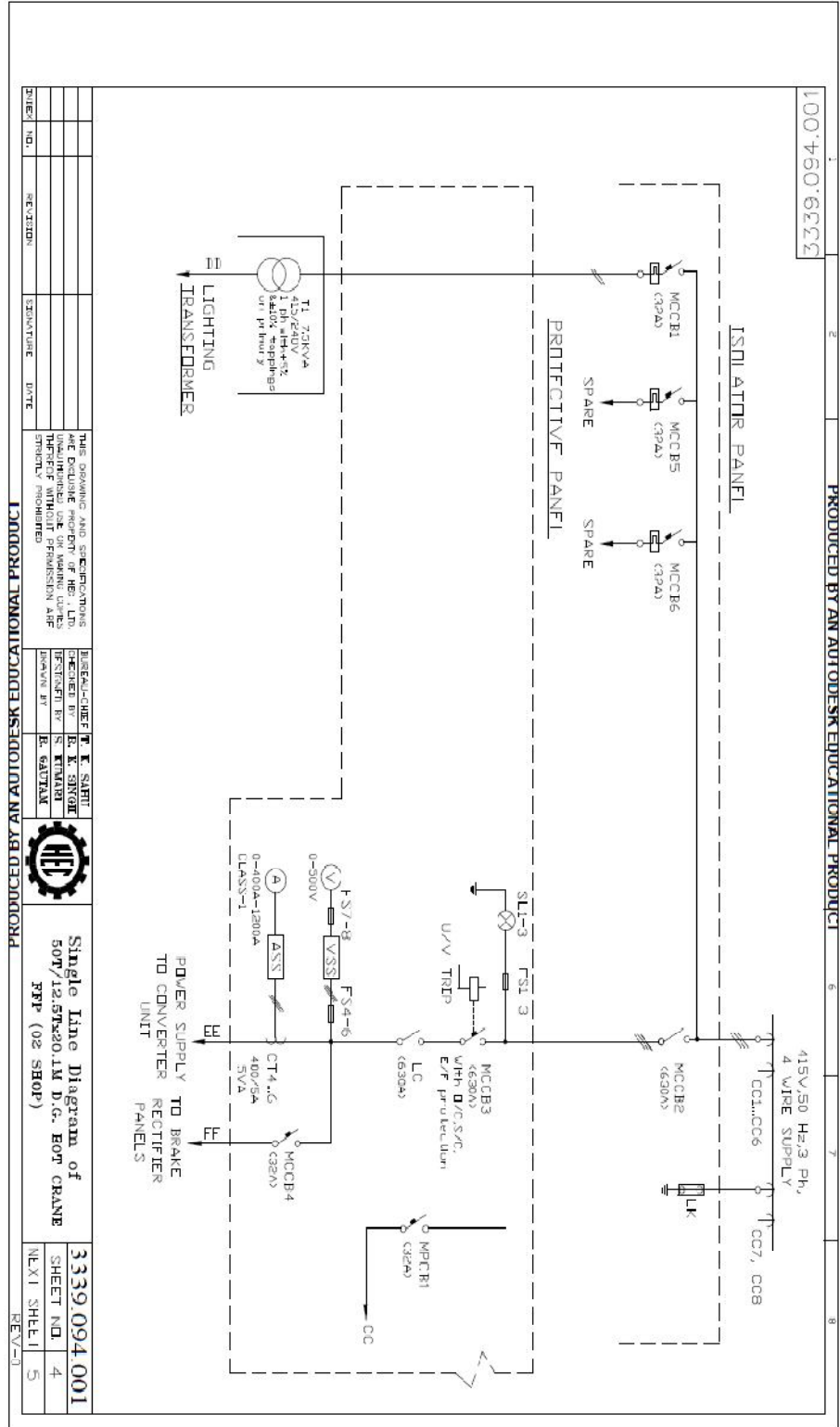

DATE	REVISED	DATE	DESCRIPTION

THIS DRAWING AND SPECIFICATIONS ARE DESIGN PROPERTY OF HEC LTD. AND SHALL BE KEPT IN CONFIDENTIALITY. THESE SPECIFICATIONS ARE NOT TO BE REPRODUCED OR COPIED WITHOUT PERMISSION AND ARE STRICTLY PROHIBITED.

DESIGNED BY	DR. K. S. SARKAR
CHECKED BY	S. K. SARKAR
APPROVED BY	E. SAHAY

Single Line Diagram of  
50T/12.5T/20.1M D.G. HOPE CRANE  
FFP (02 SHOP)

3339.094.001
SHEET NO. 4
NEXT SHEET 5

REV-1

3339.094.001 PRODUCED BY AN AUTODESK EDUCATIONAL PRODUCT



एच०ई०सी०

ISO 9001:2000

# HEAVY MACHINE BUILDING PLANT HEAVY ENGINEERING CORPORATION LIMITED

(A Govt. of India Enterprise)  
Ranchi – 834 004 (INDIA)

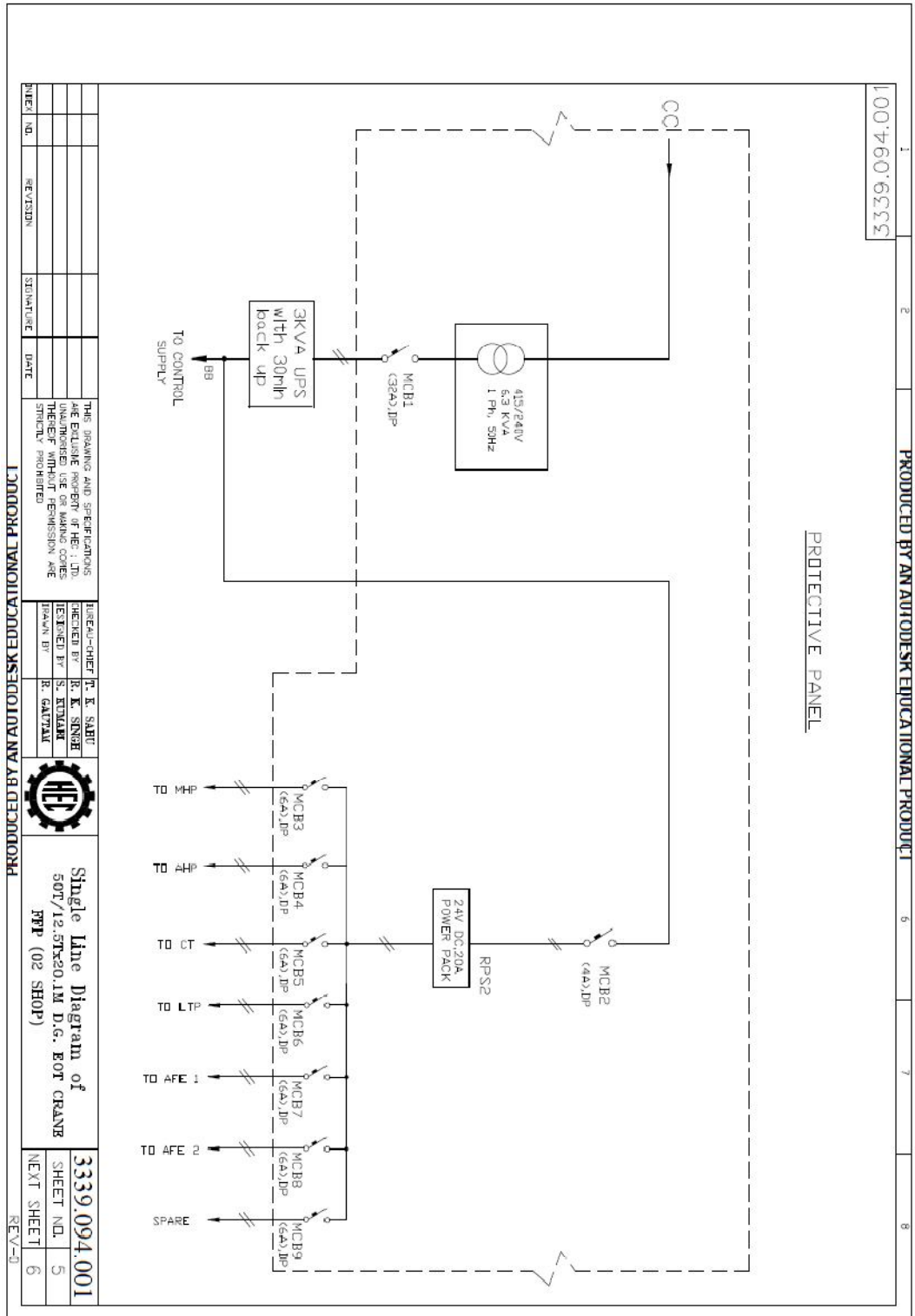



एच॰ई॰सी॰

ISO 9001:2000

# HEAVY MACHINE BUILDING PLANT HEAVY ENGINEERING CORPORATION LIMITED

(A Govt. of India Enterprise)  
Ranchi – 834 004 (INDIA)

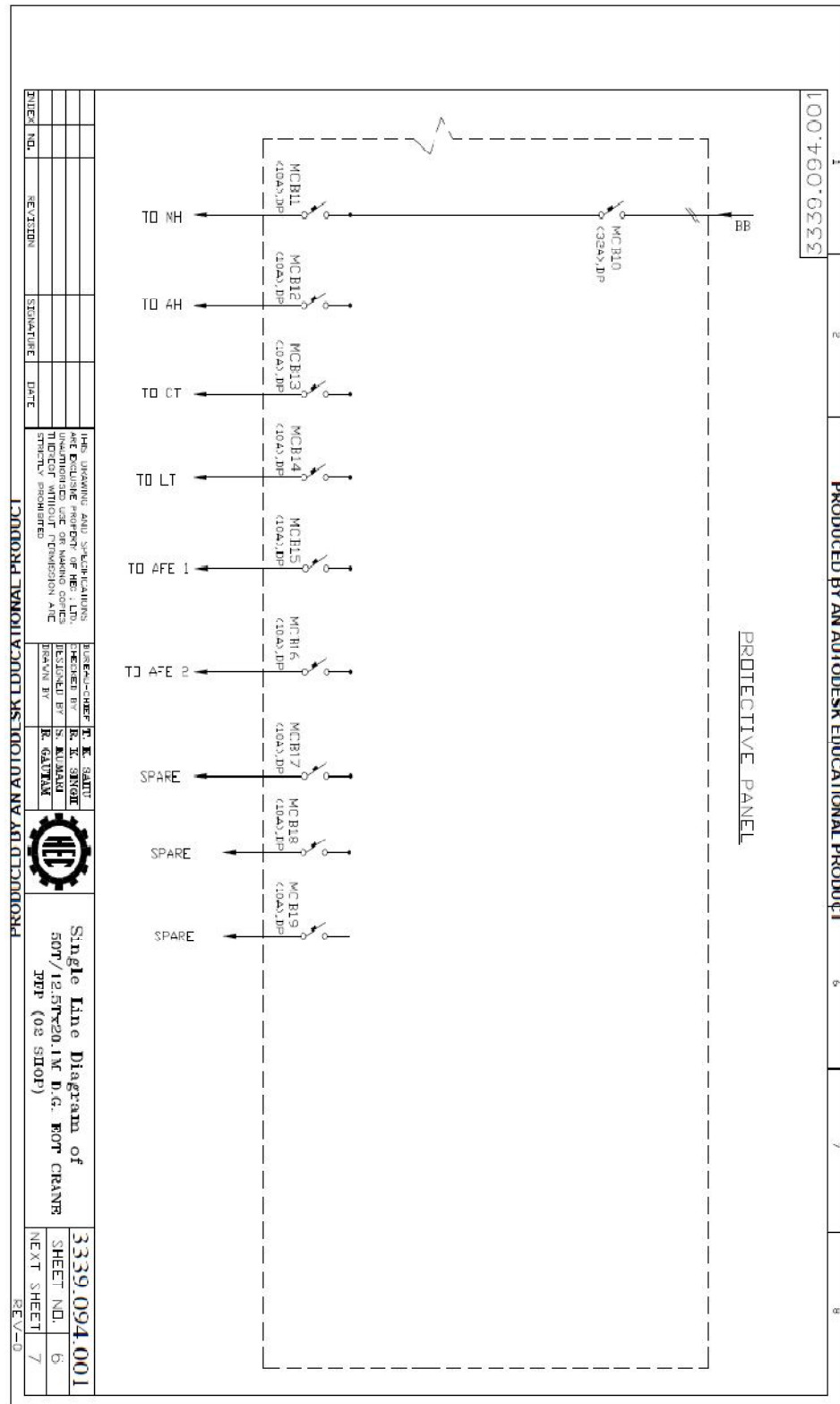





एच॰ई॰सी॰

ISO 9001:2000

# HEAVY MACHINE BUILDING PLANT HEAVY ENGINEERING CORPORATION LIMITED

(A Govt. of India Enterprise)  
Ranchi – 834 004 (INDIA)

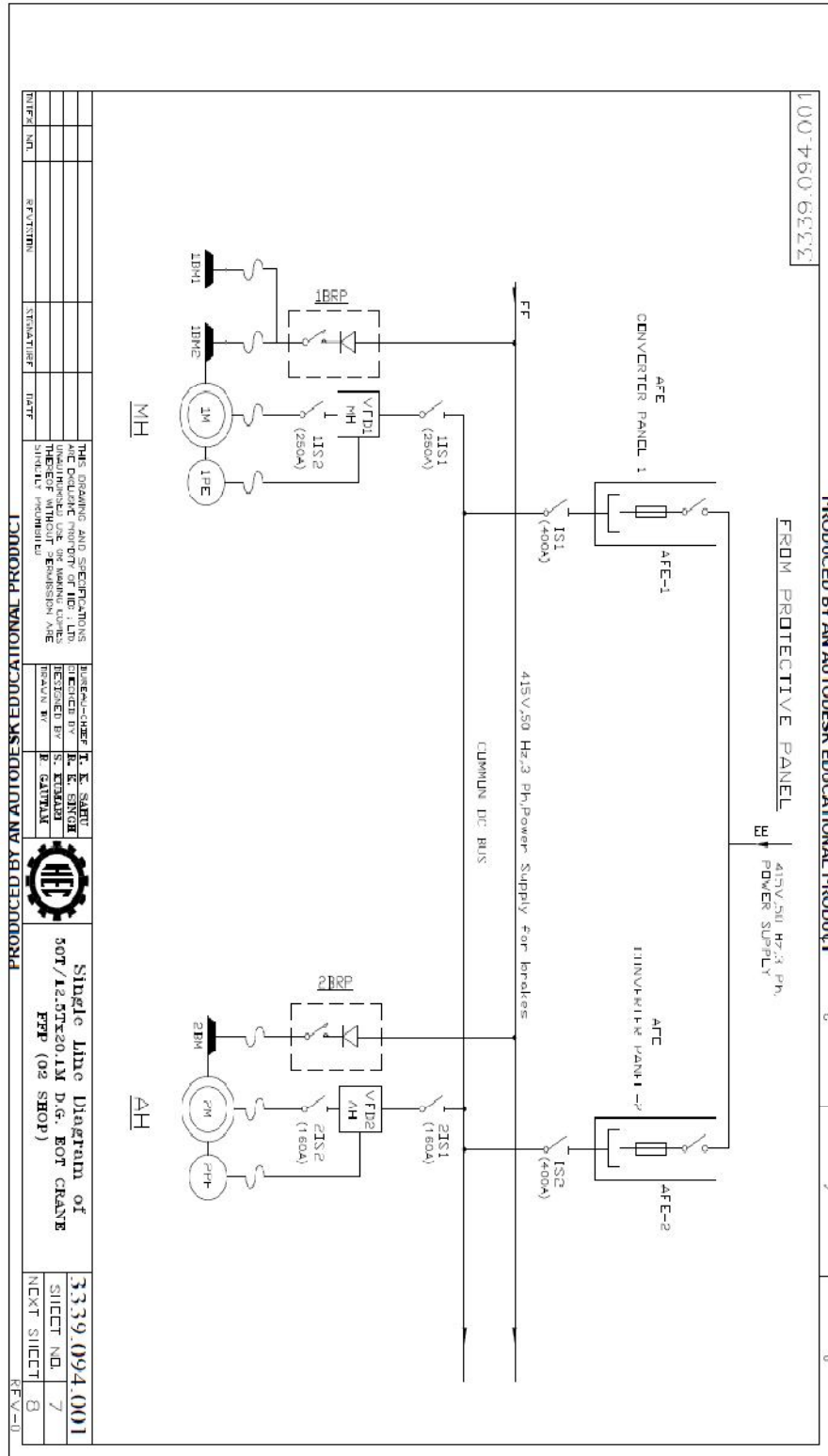



एच॰ई॰सी॰

ISO 9001:2000

# HEAVY MACHINE BUILDING PLANT HEAVY ENGINEERING CORPORATION LIMITED

(A Govt. of India Enterprise)  
Ranchi – 834 004 (INDIA)

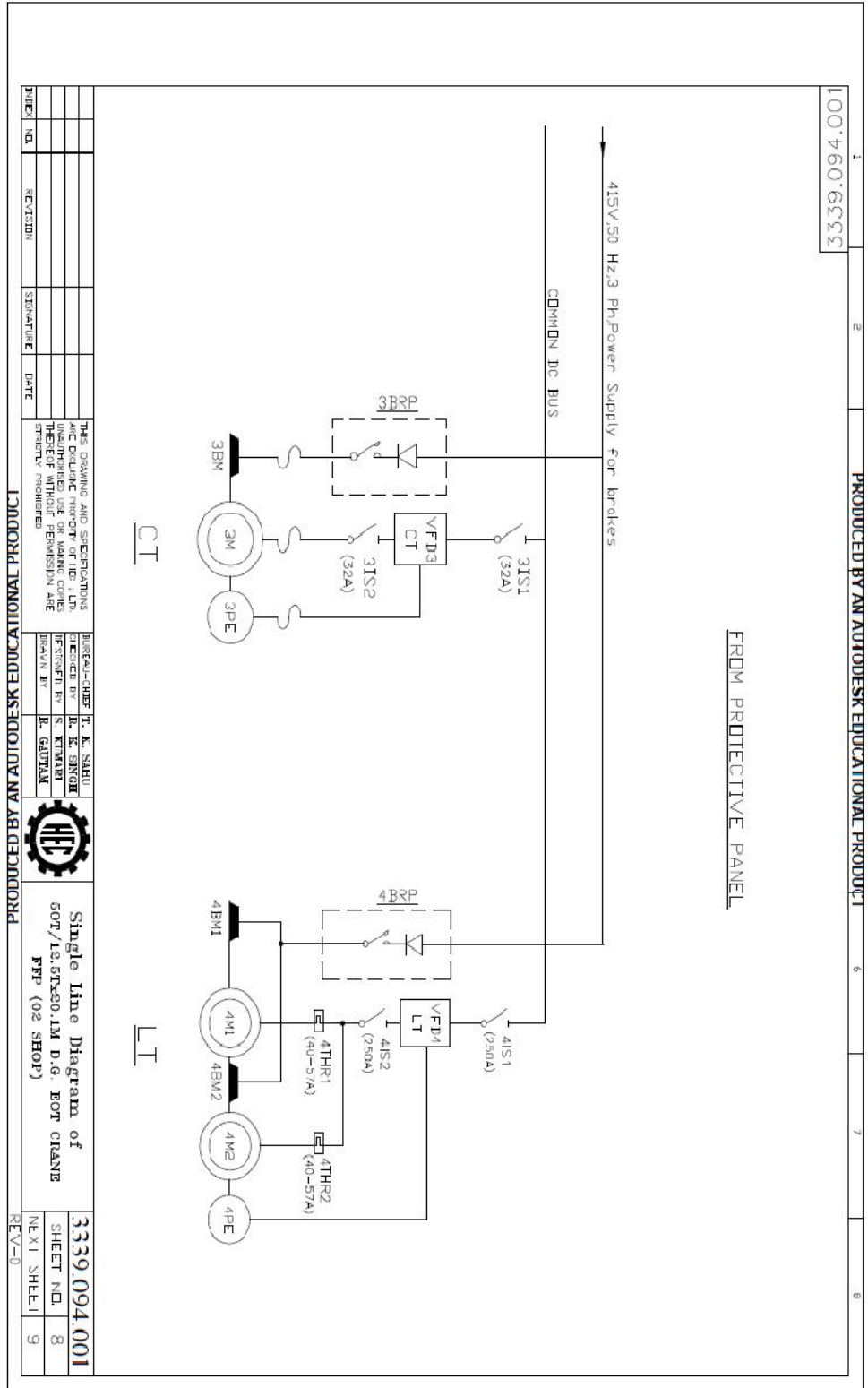



एच०ई०सी०

ISO 9001:2000

# HEAVY MACHINE BUILDING PLANT HEAVY ENGINEERING CORPORATION LIMITED

(A Govt. of India Enterprise)  
Ranchi – 834 004 (INDIA)

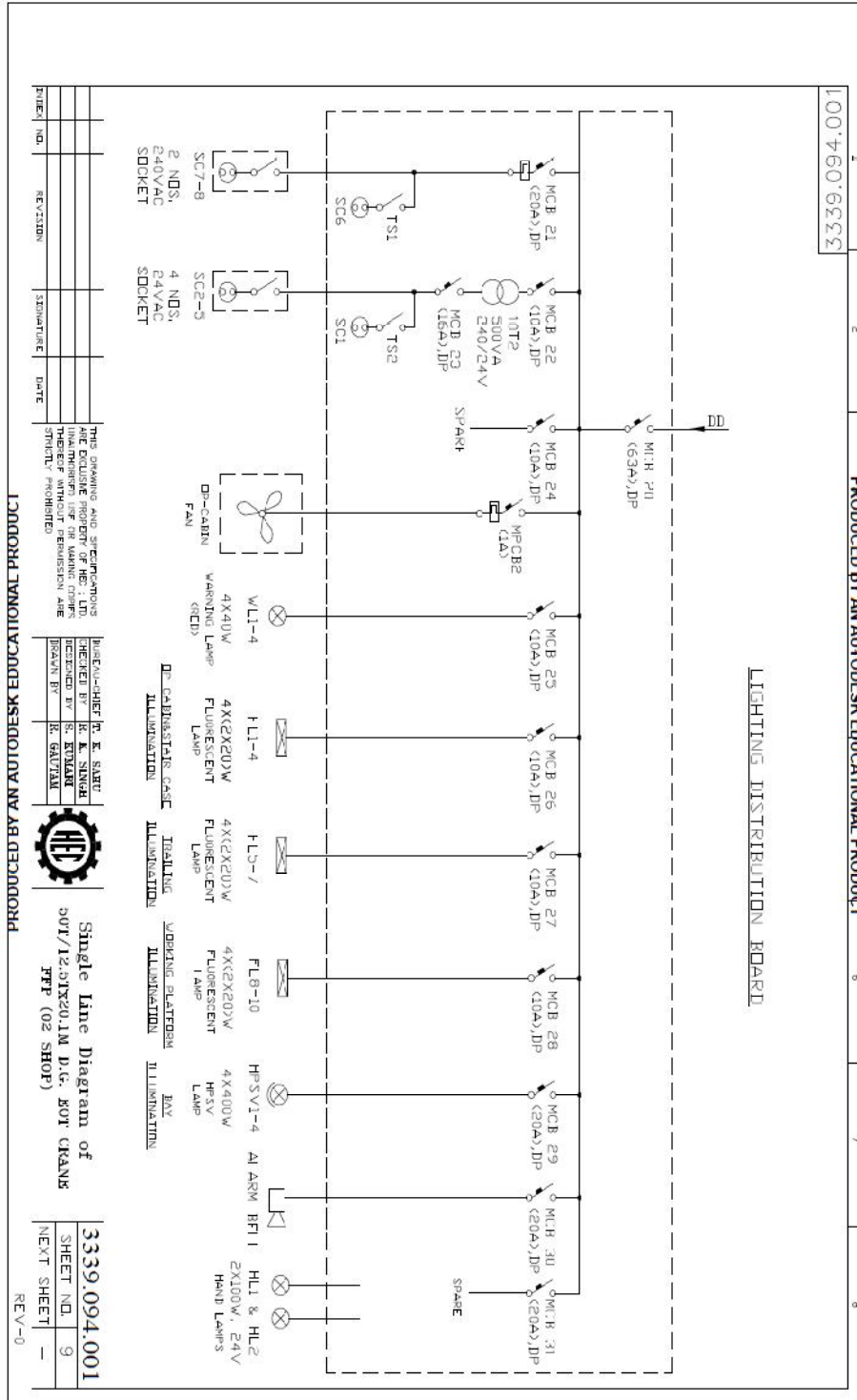



एच॰ई॰सी॰

ISO 9001:2000

# HEAVY MACHINE BUILDING PLANT HEAVY ENGINEERING CORPORATION LIMITED

(A Govt. of India Enterprise)  
Ranchi – 834 004 (INDIA)

